

NIGHT COMPLEMENTS

Poliform

Poliform

Poliform presenta la collezione di letti, complementi e accessori per la zona notte. Arredi che uniscono eleganza e comfort, pensati per rendere personali ed esclusivi gli spazi dedicati all'intimità e alla quiete. Letti che invitano al relax e assicurano la massima qualità del riposo. Comodini e cassettiere in cui funzionalità ed estetica trovano il perfetto equilibrio. Materiali, lavorazioni e dettagli richiamano quelli della zona giorno, creando continuità tra le aree della casa – in puro stile Poliform.

Poliform presents the collection of beds, complements, and accessories for the night area. Furnishings that combine elegance and comfort, designed to make the spaces dedicated to intimacy and tranquillity personal and exclusive. Beds that invite you to relax and ensure maximum quality of rest. Nightstands and dressers where functionality and aesthetics find the perfect balance. Materials and details reference those of the day area, creating continuity among the areas of the house – in pure Poliform style.

COLLECTIONS

LETTI BEDS	7
CONTENITORI STORAGE UNITS	157
SPECCHI MIRRORS	259
ACCESSORI LETTO BED ACCESSORIES	293
DATI TECNICI TECHNICAL DATA	305

BEDS

Offrire la migliore esperienza del riposo, sempre: questa è la filosofia che ispira la collezione di letti Poliform. Carlo Colombo, Rodolfo Dordoni, Emmanuel Gallina, Jean-Marie Massaud, Paolo Piva e Marcel Wanders danno ciascuno la propria interpretazione del letto, tra classicità ed eleganza. Il risultato è una serie di proposte dal design riconoscibile e contemporaneo, che sperimenta nuove ampiezze e profondità, gioca con l'idea di morbidezza e abbondanza e conquista per lo stile e la personalità.

Offering the best rest experience, always: this is the philosophy that inspires the Poliform collection of beds. Carlo Colombo, Rodolfo Dordoni, Emmanuel Gallina, Jean-Marie Massaud, Paolo Piva, and Marcel Wanders each give their own interpretation of the bed, between classicism and elegance. The result is a series of offers with a recognizable and contemporary design, which experiments with new widths and depths, plays with the idea of softness and abundance, and captivates with style and personality.

BEDS

KELLY	11
PARK 1	31
JACQUELINE	47
REVER	67
CHLOE	81
DREAM	95
ONDA	115
LAZE	127
ARCA	141



KELLY

L'armonica combinazione di finiture diverse caratterizza il letto Kelly, disegnato da Emmanuel Gallina. La base in legno massello, disponibile anche rivestita in tessuto o pelle, è slanciata e leggera mentre il giroletto imbottito, in tessuto o pelle come la testata, rende il letto accogliente. Preziosa e romantica la testata nella variante con interno in pelle Nabuk intrecciata, una lavorazione che per artigianalità ed eleganza è affine all'estetica della moda.

The harmonious combination of different finishes characterizes the Kelly bed, designed by Emmanuel Gallina. The solid wood base, also available upholstered in fabric or leather, is slender and light, while the upholstered bed frame, in fabric or leather like the headboard, makes the bed cosy. Precious and romantic is the headboard in the variant with interwoven Nabuk leather interior, a detail that, for craftsmanship and elegance, is akin to fashion aesthetics.

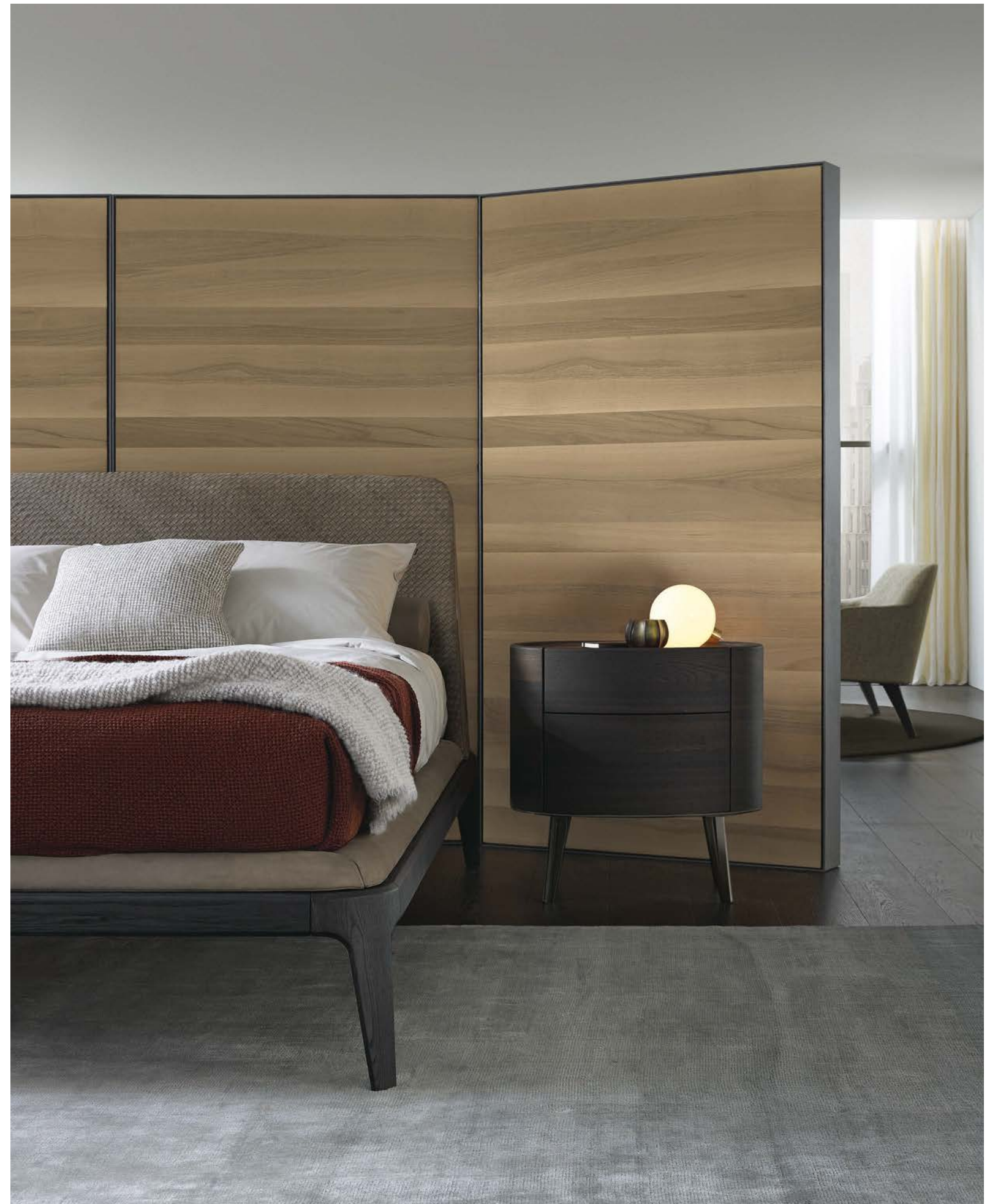



Qui e nelle pagine precedenti: letto Kelly, testata imbottita con rivestimento non sfoderabile, esterno in pelle Nabuk 02 tortora, interno in pelle Nabuk intrecciata 02 tortora. Base letto in rovere spessart e parte interna con rivestimento non sfoderabile in pelle Nabuk 02 tortora. Biancheria da letto coordinata in cotone Provence 08 polvere con profili bianco e polvere. Comodini Kelly in rovere spessart con top laccato lucido caramello e piedini in brown nickel lucido. Poltrona e panca Jane in tessuto sfoderabile Paros 06 arena, basamento in brown nickel lucido. Armadio Senzafine Bangkok in cuoio 28 avorio e Quid integrato con boiserie in olmo nero. Tappeto Soft.

Here and on the previous pages: Kelly bed, padded headboard with non-removable covering, outer part in leather Nabuk 02 tortora, inner part in woven leather Nabuk 02 tortora. Bed frame in spessart oak and inner part with non-removable covering in leather Nabuk 02 tortora. Matching bed linen in cotton Provence 08 polvere with profiles in bianco and polvere. Kelly night tables in spessart oak with caramello glossy lacquered top and feet in glossy brown nickel. Jane armchair and bench in removable fabric Paros 06 arena, base in glossy brown nickel. Senzafine Bangkok wardrobe in hide 28 avorio and integrated Quid with wall panelling in black elm. Carpet Soft.





Qui e nella pagina precedente: letto Kelly, testata imbottita con rivestimento non sfoderabile, esterno testata e rulli in pelle Silk 12 senape, interno testata in tessuto Arcadia 05 bronzo. Base letto in noce gold e parte interna con rivestimento non sfoderabile in pelle Silk 12 senape. Biancheria da letto coordinata in cotone Provence 01 bianco e 07 grafite con profili nero. Nella pagina successiva: letto Kelly, testata e base imbottite con rivestimento sfoderabile in tessuto Naxos 27 prussia, interno testata in tessuto Kitami 11 oceano. Rulli in tessuto Naxos 27 prussia. Biancheria da letto coordinata in cotone Provence 01 bianco con profilo nero e 08 polvere con profilo polvere.

Here and on the previous page: Kelly bed, padded headboard with non-removable covering, outer headboard and roll cushions in leather Silk 12 senape, inner headboard in fabric Arcadia 05 bronzo. Bed frame in gold walnut and inner part with non-removable covering in leather Silk 12 senape. Matching bed linen in cotton Provence 01 bianco and 07 grafite with profiles in nero. On the next page: Kelly bed, padded headboard and bed frame with removable covering in fabric Naxos 27 prussia, inner headboard in fabric Kitami 11 oceano. Roll cushions in fabric Naxos 27 prussia. Matching bed linen in cotton Provence 01 bianco with profile in nero and 08 polvere with profile in polvere.

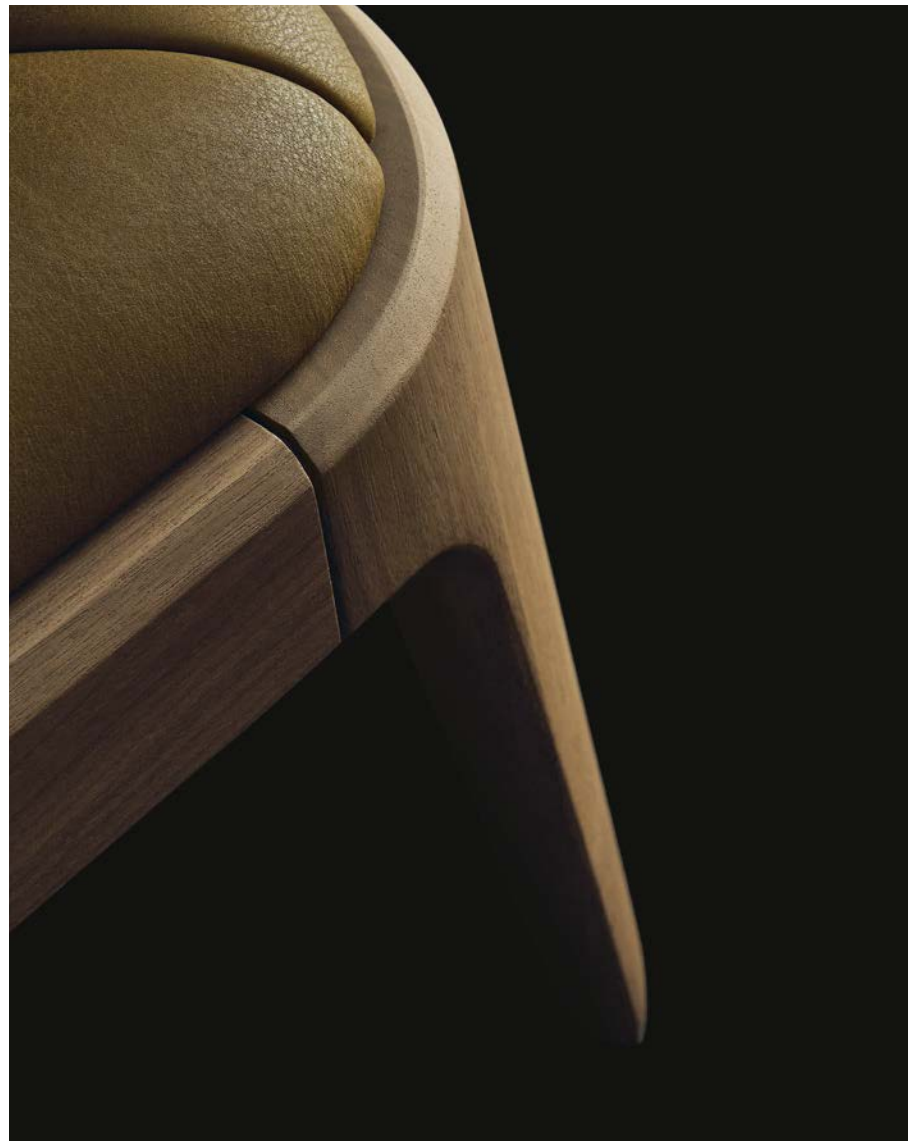





Qui, nella pagina precedente e nella successiva: letto Kelly, testata e base imbottite con rivestimento sfoderabile in tessuto Naxos 16 sabbia, interno testata in tessuto Sendai 01 cenere. Biancheria da letto coordinata in cotone Provence 01 bianco con profilo polvere e 08 polvere con profilo bianco. Comodino Kelly in olmo nero con top in cuoio 26 invecchiato. Poltrone e pouf Jane Large con rivestimento non sfoderabile in pelle Nabuk 09 ruggine e basamento in olmo nero. Sistema a giorno Quid in olmo nero, schienali in laccato lucido corda, ripiani in olmo nero e vetro. Pouf Play con rivestimento sfoderabile in tessuto Sendai 02 tortora.

Here, on the previous page and next page: Kelly bed, padded headboard and bed frame with removable covering in fabric Naxos 16 sabbia, inner headboard in fabric Sendai 01 cenere. Matching bed linen in cotton Provence 01 bianco with profile in polvere and Provence 08 polvere with profile in bianco. Kelly night table in black elm with top in hide 26 invecchiato. Jane armchair and pouf with non-removable covering in leather Nabuk 09 ruggine and base in black elm. Quid open system in black elm, backs in glossy lacquered corda, shelves in black elm and glass. Play pouf with removable covering in fabric Sendai 02 tortora.





KELLY

Design Emmanuel Gallina, 2016

Letto con testata imbottita in poliuretano stampato e prerivestimento in ovatta di poliestere. Rivestimento in tessuto sfoderabile o pelle non sfoderabile. Possibilità di rivestimento diverso tra interno ed esterno della testata, in questa versione il rivestimento con la combinazione di un tessuto con una pelle sarà sfoderabile ma non lavabile.

Base in massello, finitura in rovere spessart e olmo nero con parte interna imbottita e rivestita in tessuto o pelle non sfoderabile.

Base imbottita con rivestimento sfoderabile in tessuto o pelle.

Coppia rulli opzionale con rivestimento sfoderabile in tessuto o pelle.

Predisposto per materassi:

l 1600-1800 x p 2000

Queen size letto l 1694 x p 2332

materasso l 1525 x p 2030

King size letto l 2100 x p 2332

materasso l 1930 x p 2030

Tipologia di rete:

rete fissa a doghe flessibili

Bed with padded headboard in moulded polyurethane foam and pre-covering in polyester wadding. Removable fabric or non-removable leather covering. Possibility for different type of covering on inner and outer part of headboard, in this version the combined fabric and leather covering is removable but not washable.

Bed frame in solid wood, finished in spessart oak and black elm with padding on inner part, covering in non-removable leather or fabric.

Padded bed frame with removable fabric or leather covering.

Optional pair of roll cushions with removable fabric or leather covering.

For mattresses:

w 63"-70 3/4" x d 78 3/4"

Queen size bed w 66 3/4" x d 91 3/4"

for mattress w 60" x d 80"

King size bed w 82 3/4" x d 91 3/4"

for mattress w 76" x d 80"

Bedstead type:

fixed with flexible slats

Base legno Wooden bed frame

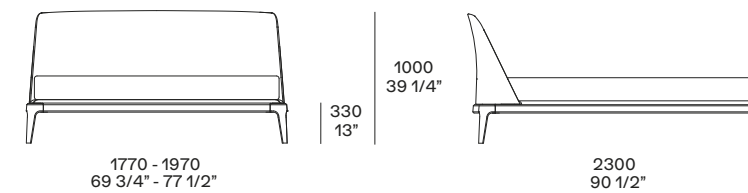

Base imbottita Padded bed frame

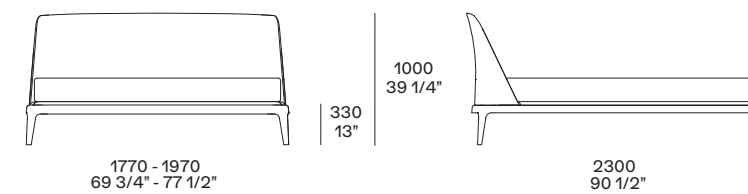

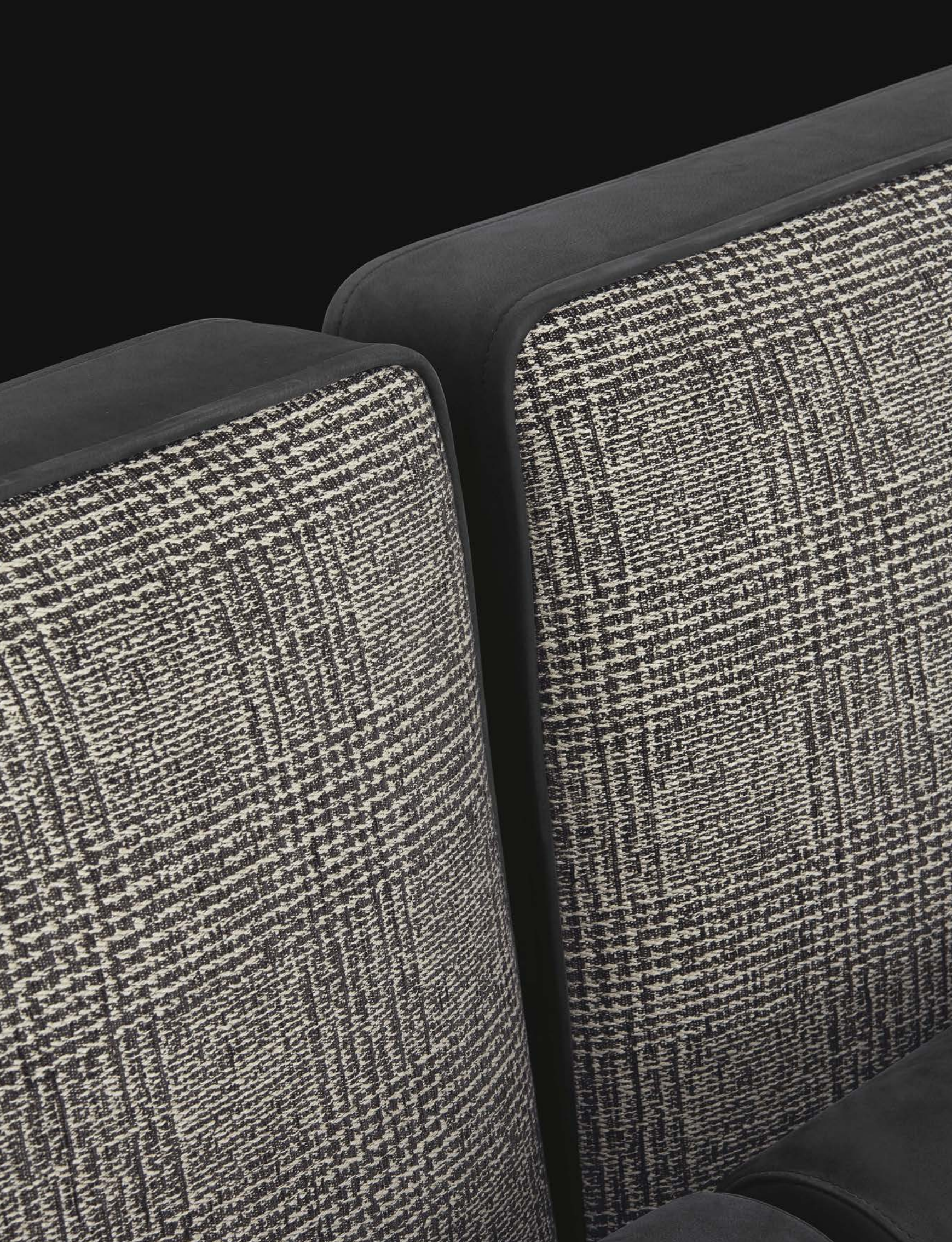

PARK 1

Carlo Colombo firma un letto che unisce alle proporzioni generose della testata la leggerezza dei piedini e del giroletto in metallo rivestito in pelle. La testata, morbida e piena, è costituita da due maxi cuscini. Profili e retro sono disponibili anche in pelle.

Carlo Colombo designs a bed that combines the generous proportions of the headboard with the lightness of the feet and of the metal bed frame covered in leather. The headboard, soft and full, consists of two maxi cushions. Profiles and back are also available in leather.







Qui, nelle pagine precedenti e in chiusura: letto Park 1, testata imbottita con rivestimento sfoderabile, esterno in pelle Soft 14 oliva e interno in tessuto Nayoro 02 sabbia. Base letto in brown nickel opaco e pelle sfoderabile Soft 14 oliva. Biancheria da letto coordinata in cotone Provence 03 ghiaccio, 06 roccia con profilo ghiaccio e 03 ghiaccio con profilo roccia. Panca Park, seduta con rivestimento non sfoderabile in pelle Soft 14 oliva, struttura in brown nickel opaco e pelle non sfoderabile Soft 14 oliva. Comodini Abbinabili in rovere spessart. Tavolini Soori in metallo finitura bronzo anticato. Poltrone Stanford con rivestimento non sfoderabile in tessuto Orleans 12 carbone, basamento girevole in brown nickel lucido.

Here, on the previous pages and at the end: Park 1 bed, padded headboard with removable covering, outer part in leather Soft 14 oliva and inner part in fabric Nayoro 02 sabbia. Bed frame in mat brown nickel and removable leather Soft 14 oliva. Matching bed linen in cotton Provence 03 ghiaccio, 06 roccia with profile in ghiaccio and 03 ghiaccio with profile in roccia. Park bench, seat with non-removable covering in leather Soft 14 oliva, structure in mat brown nickel and non-removable leather Soft 14 oliva. Abbinabili night tables in spessart oak. Soori coffee tables in antique bronze finished metal. Stanford armchairs with non-removable covering in fabric Orleans 12 carbone, swivel base in glossy brown nickel.

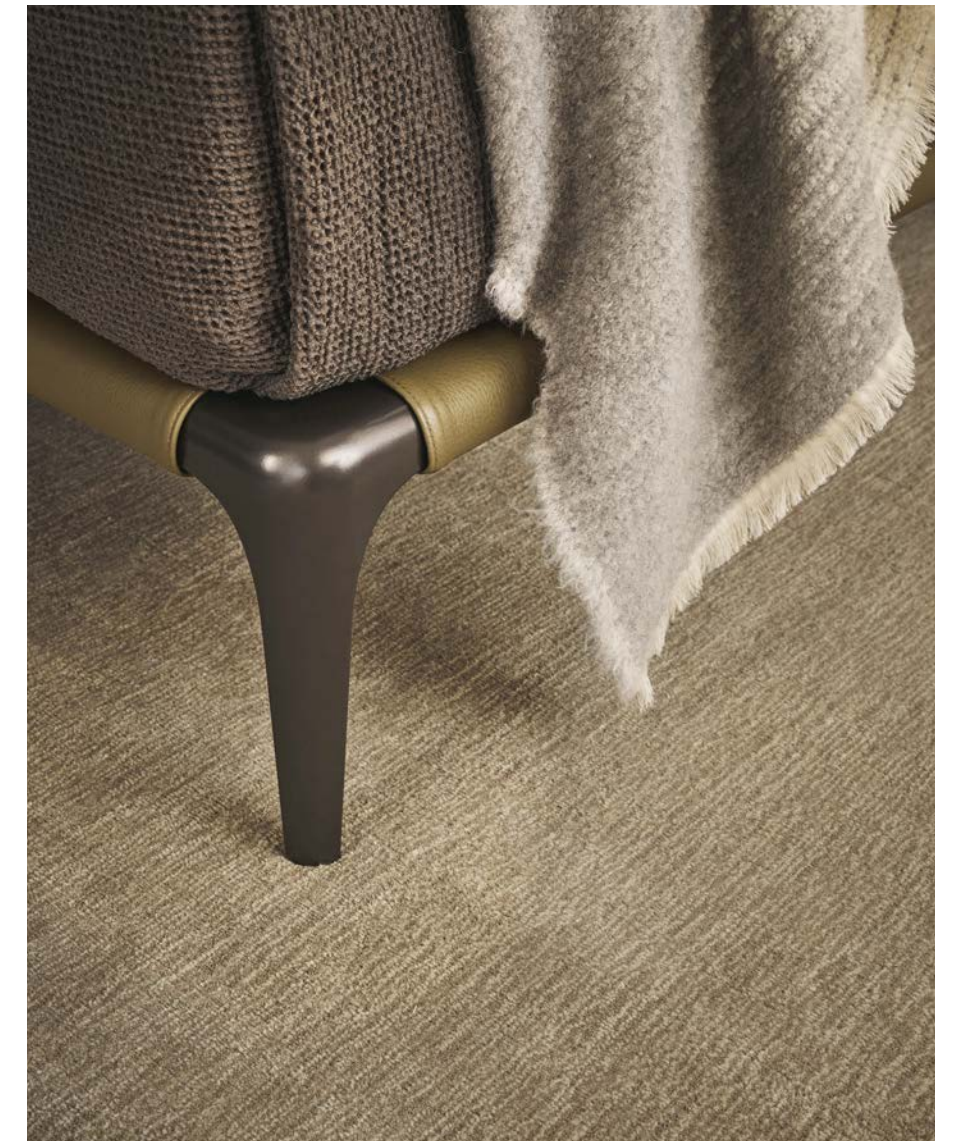

Qui e nella pagina successiva: letto Park 1, testata imbottita con rivestimento sfoderabile, esterno in pelle Nabuk 05 grafite e interno in tessuto Sendai 03 fango. Base letto in brown nickel opaco e tessuto Sendai 03 fango. Rulli in pelle Nabuk 05 grafite. Biancheria da letto coordinata in cotone Provence 01 bianco e 03 ghiaccio con profili nero.

Here and on the next page: Park 1 bed, padded headboard with removable covering, outer part in leather Nabuk 05 grafite and inner part in fabric Sendai 03 fango. Bed frame in mat brown nickel and fabric Sendai 03 fango. Roll cushions in leather Nabuk 05 grafite. Matching bed linen in cotton Provence 01 bianco and 03 ghiaccio with profiles in nero.





In questa pagina: Panca Park, seduta con rivestimento sfoderabile in tessuto Arcadia 12 polvere, struttura in brown nickel lucido.

On this page: Park bench, seat with removable covering in fabric Arcadia 12 polvere, structure in glossy brown nickel.





PARK 1
Design Carlo Colombo, 2018

Letto con testata imbottita in poliuretano flessibile stampato e prerivestimento in fibra di poliestere. Rivestimento sfoderabile in tessuto o pelle. Possibilità di rivestimento diverso tra interno ed esterno della testata (incluse fasce laterali), in questa versione il rivestimento con la combinazione di un tessuto con una pelle sarà sfoderabile ma non lavabile. Base letto verniciata (e panca) in alluminio verniciato brown nickel opaco o lucido. Base letto rivestita (e panca) in alluminio con prerivestimento in fibra di poliestere e rivestimento sfoderabile in tessuto o pelle, piedini brown nickel opaco o lucido. Panca Park con cuscino seduta rivestimento sfoderabile in tessuto o pelle. Coppia rulli opzionale con rivestimento sfoderabile in tessuto o pelle.

Predisposto per materassi:
l 1600-1800 x p 2000

Tipologia di rete:
rete fissa a doghe flessibili

Bed with headboard in moulded flexible polyurethane foam and pre-covering in polyester fibre. Removable fabric or leather covering. Possibility for different type of covering on inner and outer part of headboard (including side bands), in this version the combined fabric and leather covering is removable but not washable. Painted bed frame (and bench) in mat or glossy brown nickel painted aluminium. Covered bed frame (and bench) in aluminium with pre-covering in polyester fibre and removable fabric or leather covering, mat or glossy brown nickel feet. Park bench with seat cushion, removable fabric or leather covering. Optional pair of roll cushions with removable fabric or leather covering.

For mattresses:
w 63"-70 3/4" x d 78 3/4"

Bedstead type:
fixed with flexible slats

Letto base verniciata
Painted bed frame

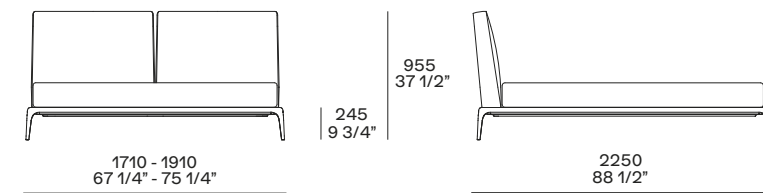

Panca base verniciata
Painted bench frame

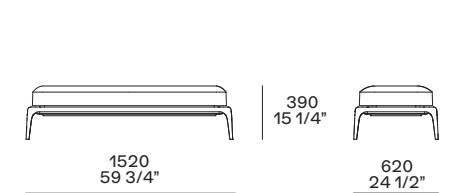

Letto base rivestita
Covered bed frame



Panca base rivestita
Covered bench frame

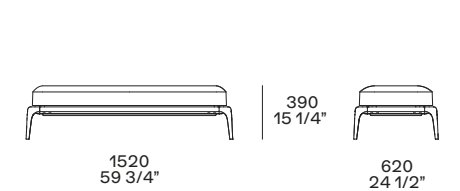

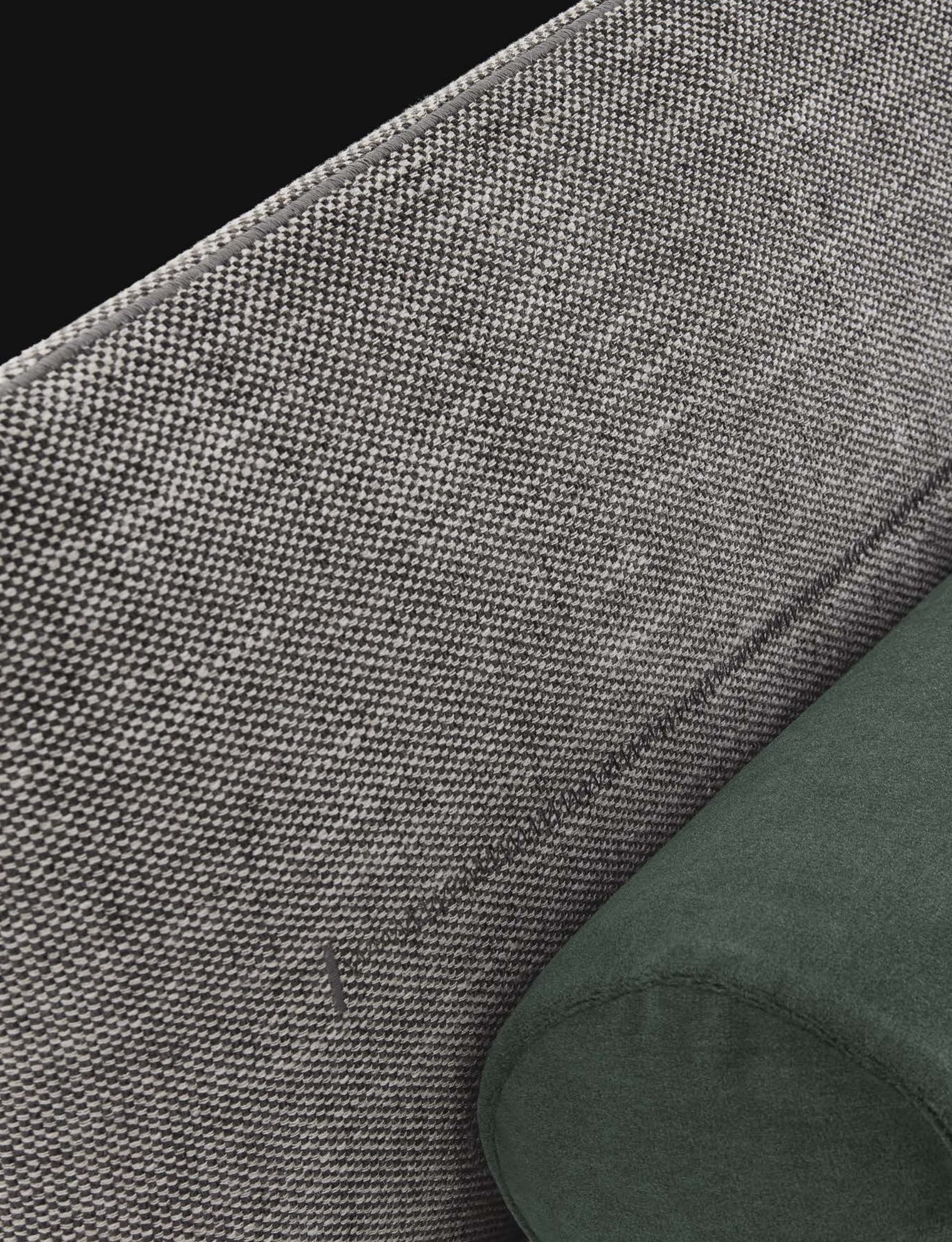

JACQUELINE

Jacqueline di Jean-Marie Massaud è un letto tessile dall'aspetto confortevole e dallo stile informale. Nella versione in tessuto, testata e giroletto sono caratterizzati dagli inserti ricamati e dagli alamari in colori a contrasto. Doppio o singolo, Jacqueline è disponibile anche rivestito in pelle.

Jacqueline by Jean-Marie Massaud is a comfortable textile bed with an informal style. In the fabric version, headboard and bed frame are characterized by embroidered inserts and fasteners in contrasting colours. Double or single, Jacqueline is also available in leather.

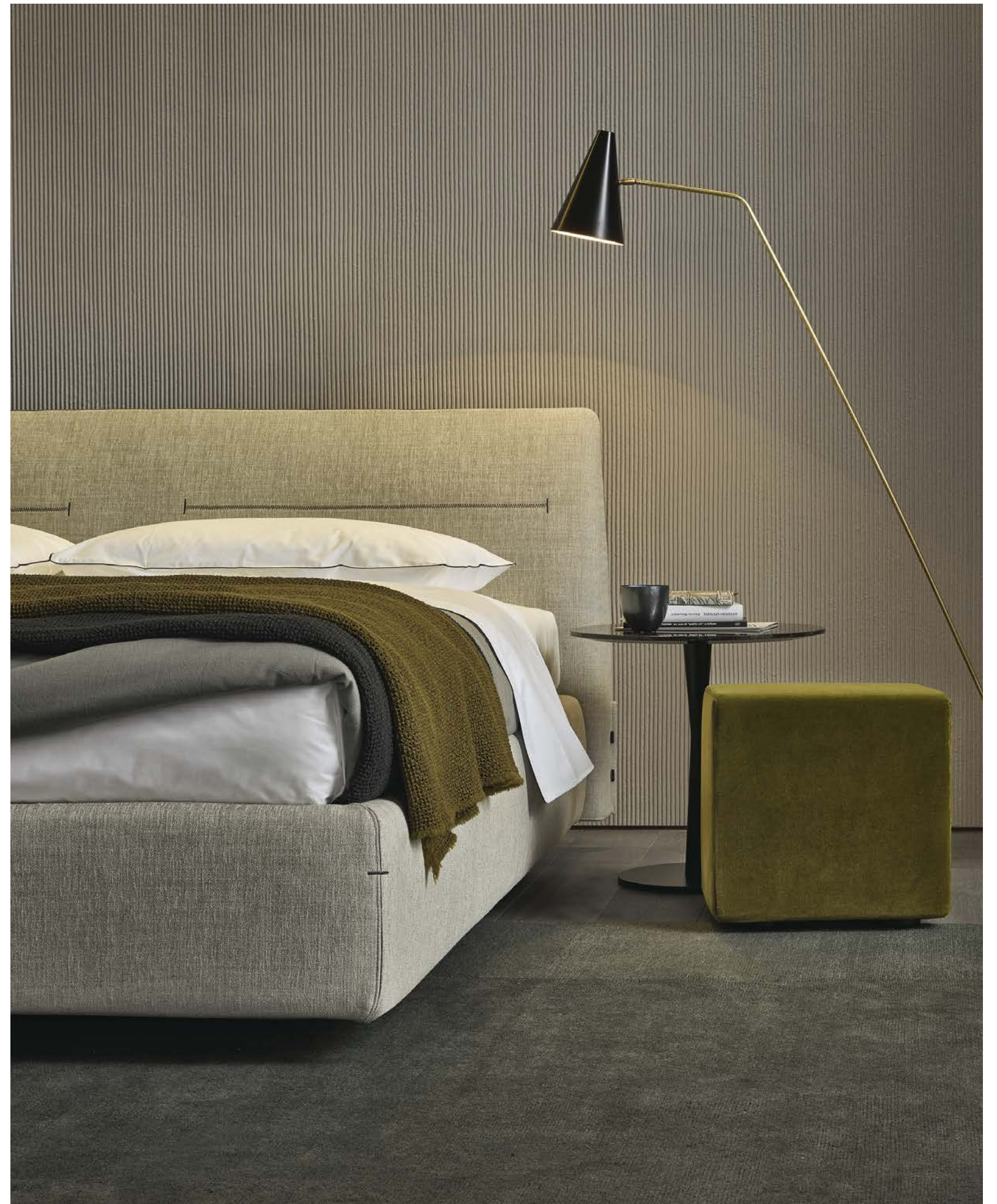



Qui, nelle pagine precedenti e in chiusura: letto Jacqueline, testata e base imbottite con rivestimento sfoderabile in tessuto Lima 43 é cru e cuciture a cordoncino in colore acciaio. Biancheria da letto coordinata in cotone Provence 01 bianco con profilo nero e 06 roccia. Tavolino Flute laccato opaco nero e piano in marmo emperador dark lucido. Pouf Play rivestimento sfoderabile in velluto Persia 1403 ocra. Comodino Pandora in rovere spessart. Poltrona Mad Chair rivestimento in velluto sfoderabile Persia 1401 oliva, gambe in rovere spessart. Tappeto Dama. Sotto: un dettaglio della cucitura della base. La testata è caratterizzata dalla cucitura a cordoncino perimetrale, dagli alamari e da un inserto con cuciture a contrasto.

Here, on the previous pages and at the end: Jacqueline bed, padded headboard and bed frame with removable covering in fabric Lima 43 é cru and piping in colour acciaio. Matching bed linen in cotton Provence 01 bianco with profile in nero and Provence 06 roccia. Flute coffee table in mat lacquered nero with glossy emperador dark marble top. Play pouf with removable covering in velvet Persia 1403 ocra. Pandora night table in spessart oak. Mad Chair armchair with removable covering in velvet Persia 1401 oliva, legs in spessart oak. Carpet Dama. Below: a detail of the bed frame stitching. The headboard is characterized by perimetric piping, fasteners and an insert with contrasting stitching.







Qui e nella pagina precedente: letto Jacqueline, testata e base imbottite con rivestimento sfoderabile in tessuto Kitami 04 sabbia e cuciture a cordoncino in colore nero. Rulli in tessuto Kitami 04 sabbia. Biancheria da letto coordinata in cotone Provence 01 bianco e 07 grafite con profili nero.

Here and on the previous page: Jacqueline bed, padded headboard and bed frame with removable covering in fabric Kitami 04 sabbia and piping in colour nero. Roll cushions in fabric Kitami 04 sabbia. Matching bed linen in cotton Provence 01 bianco and 07 grafite with profiles in nero.





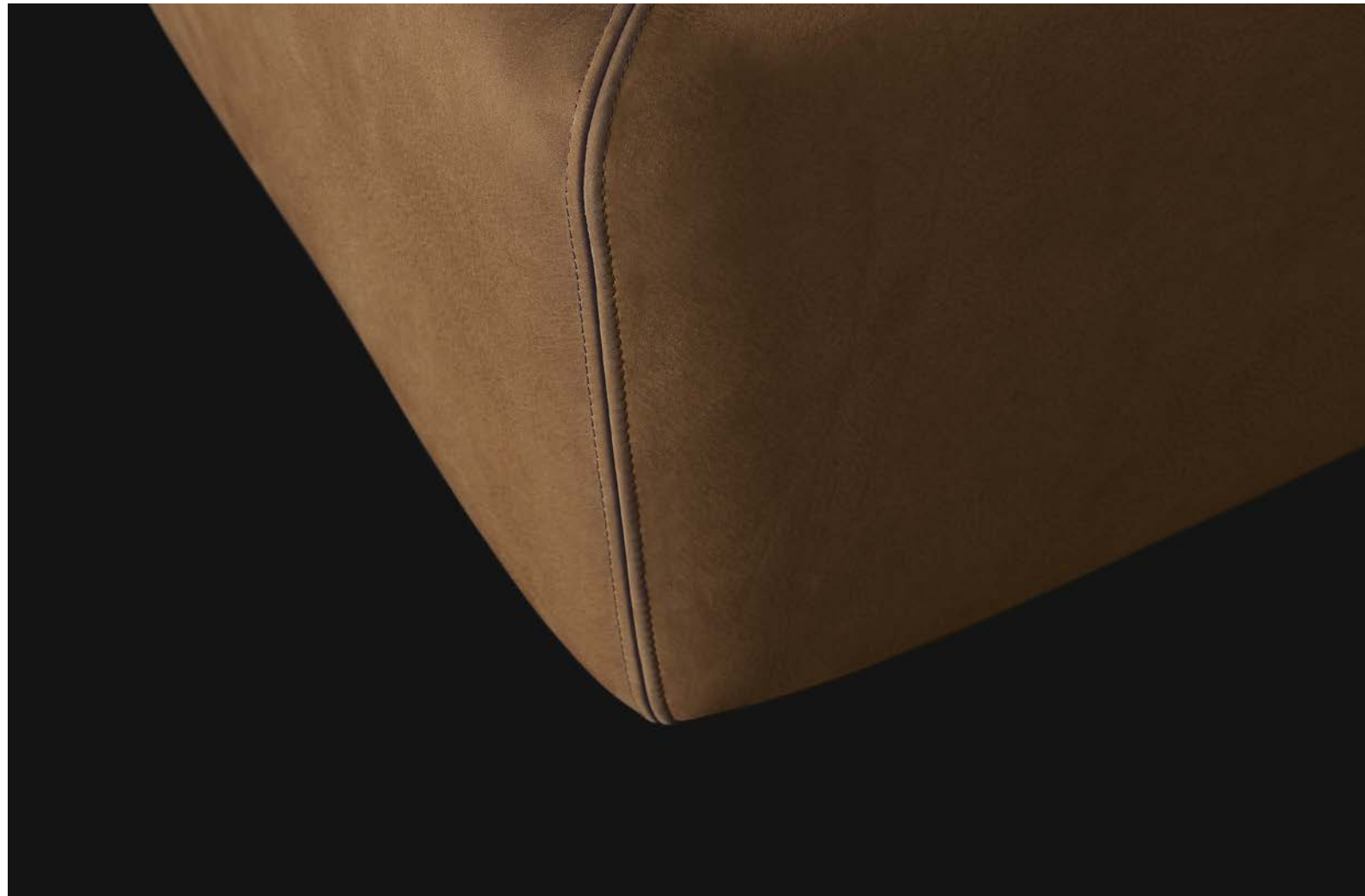

Qui e nella pagina precedente: letto Jacqueline, testata e base imbottite con rivestimento sfoderabile in pelle Nabuk 09 ruggine. Rulli in pelle Nabuk 09 ruggine. Biancheria da letto coordinata in cotone Provence 01 bianco con profilo polvere e 08 polvere con profilo bianco. Nella pagina successiva: letto singolo Jacqueline, testata e base imbottite con rivestimento sfoderabile in tessuto Rabat 412 cemento e cuciture a cordoncino in colore acciaio. Rullo in velluto Tebe 06 giada. Biancheria da letto coordinata in cotone Provence 01 bianco con profilo nero e 08 polvere con profilo polvere.

Here and on the previous page: Jacqueline bed, padded headboard and bed frame with removable covering in leather Nabuk 09 ruggine. Roll cushions in leather Nabuk 09 ruggine. Matching bed linen in cotton Provence 01 bianco with profile in polvere and 08 polvere with profile in bianco. On the next page: Jacqueline single bed, padded headboard and bed frame with removable covering in fabric Rabat 412 cemento and piping in colour acciaio. Roll cushions in velvet Tebe 06 giada. Matching bed linen in cotton Provence 01 bianco with profile in nero and 08 polvere with profile in polvere.

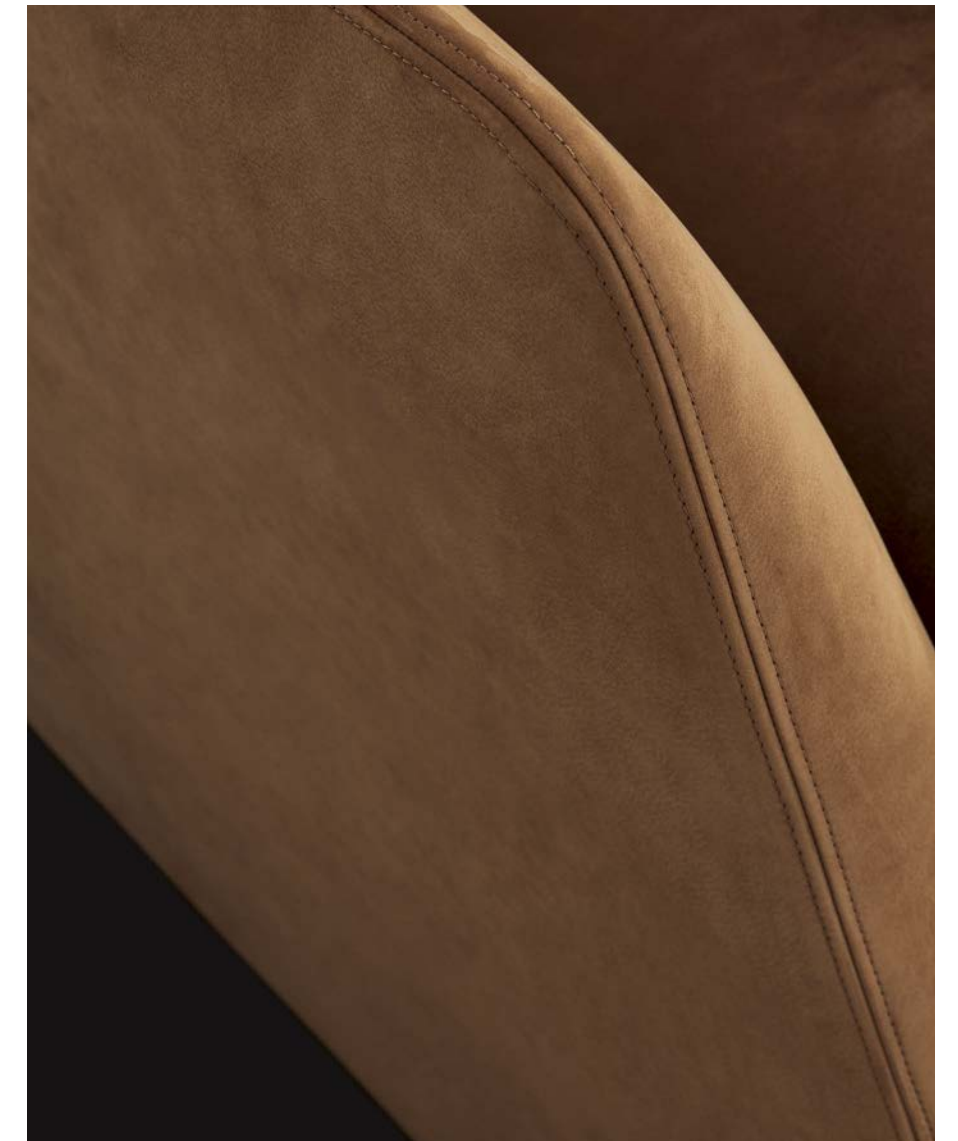





JACQUELINE

Design Jean-Marie Massaud, 2011

Letto con testata imbottita in poliuretano stampato e prerivestimento in piuma. Base letto in pannello di particelle di legno imbottito. Rivestimento sfoderabile in tessuto o pelle. Cucitura normale doppia o a cordoncino con filato nei diversi colori da campionario (escluso pelle o velluto). Nella versione in tessuto, testata con inserto centrale e alamari. Coppia rulli opzionale (escluso versione singolo) con rivestimento sfoderabile in tessuto o pelle.

Predisposto per materassi:
 I 1000-1600-1800 x p 2000-2100
Queen size letto I 1804 x p 2190
 materasso I 1525 x p 2030
King size letto I 2210 x p 2190
 materasso I 1930 x p 2030

Tipologia di rete:
 - rete fissa a doghe flessibili
 - reti anatomiche con movimento manuale
 - rete ribaltabile con pistone per base con contenitore

Bed with padded headboard in moulded polyurethane foam and pre-covering in down. Bed frame in padded particleboard. Removable fabric or leather covering. Normal double stitching or piping in the colours as per sample book (except leather or velvet). In the fabric version, headboard with central insert and fasteners. Optional pair of roll cushions (except single version) with removable fabric or leather covering.

For mattresses:
 w 39 1/4"-63"-70 3/4" x d 78 3/4"-82 3/4"
Queen size bed w 71" x d 86 1/4"
 for mattress w 60" x d 80"
King size bed w 87" x d 86 1/4"
 for mattress w 76" x d 80"

Bedstead type:
 - fixed with flexible slats
 - anatomic with manual movement
 - lifting bedstead with piston for bed frame with container

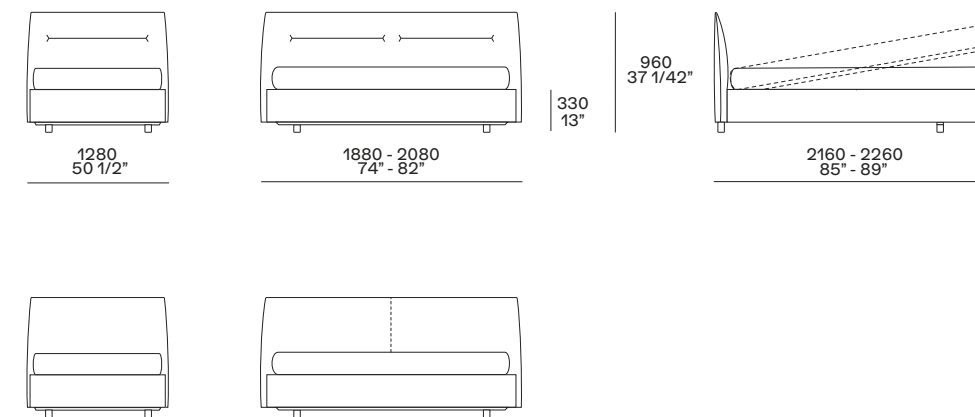

cuciture testata versione in pelle
 headboard stitching leather version

REVER

Proporzioni generose per un letto elegante e avvolgente, come il revers di una giacca da uomo. Progettato da Rodolfo Dordoni per diventare protagonista della camera da letto, dove dà il meglio di sé posizionato a centro stanza, si riconosce per la testata leggermente inclinata e la sofisticata lavorazione effetto capitoné dell'interno.

Generous proportions for an elegant and enveloping bed, like the revers of a men's jacket. Designed by Rodolfo Dordoni to become the protagonist of the bedroom, where it gives its best positioned in the centre of the room; it is recognizable by the slightly inclined headboard and the sophisticated capitoné effect detail of the interior.







Qui, nelle pagine precedenti e in chiusura: letto Rever, testata e base imbottite con rivestimento sfoderabile in tessuto Orleans 05 pernice, fasce perimetrali testata e fasce interne base letto in pelle Nabuk 01 latte. Biancheria da letto coordinata in cotone Provence 01 bianco e 08 polvere con profili nero. Tavolini Soori in metallo finitura bronzo anticato. Panca Home Hotel in olmo nero.

Here, on the previous pages and at the end: Rever bed, padded headboard and bed frame with removable covering in fabric Orleans 05 pernice, perimetric headboard bands and bed frame inner bands in leather Nabuk 01 latte. Matching bed linen in cotton Provence 01 bianco and 08 polvere with profiles in nero. Soori coffee tables in antique bronze finished metal. Home Hotel bench in black elm.





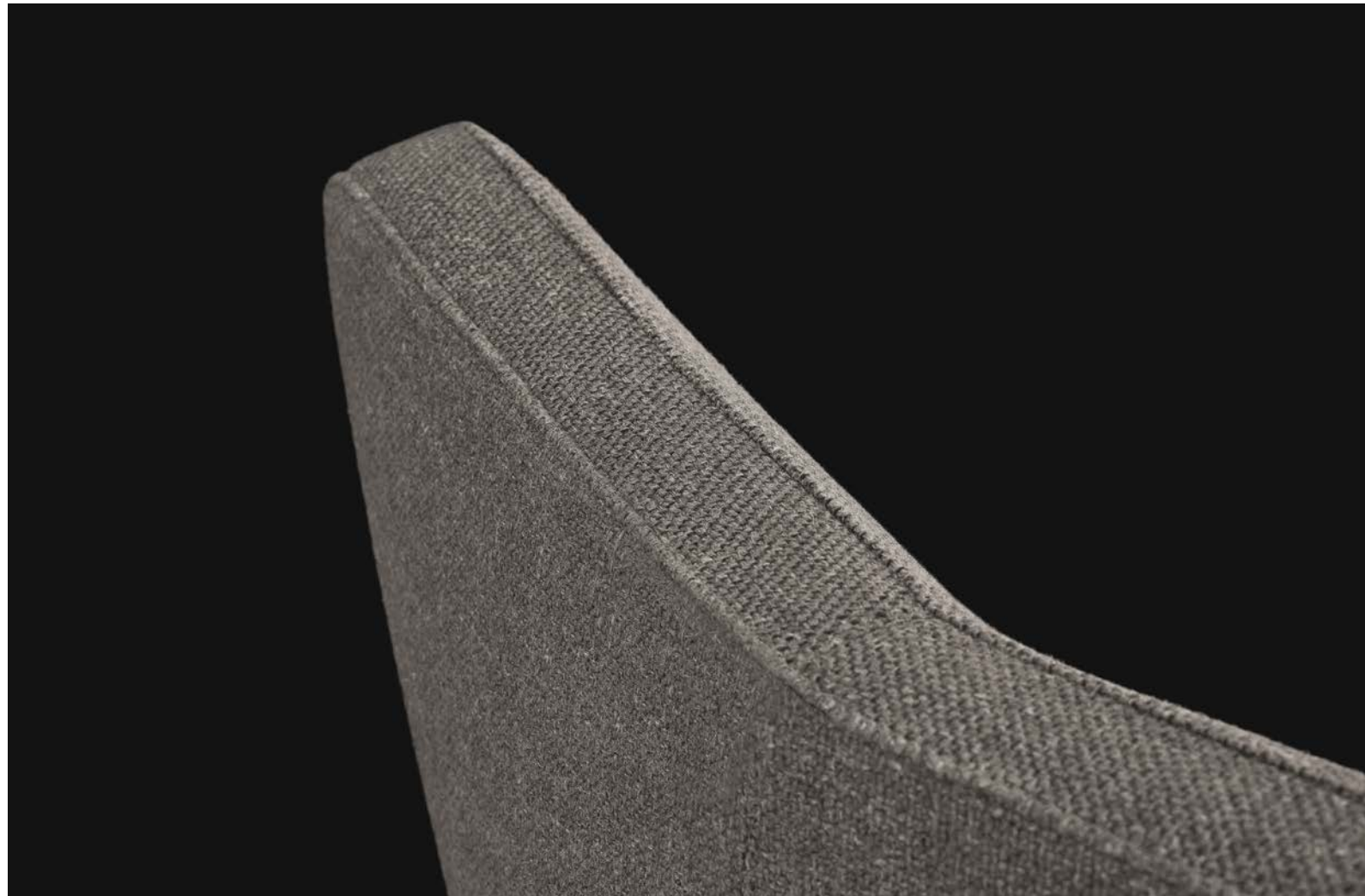

Qui e nella pagina precedente: letto Rever, testata e base imbottite con rivestimento sfoderabile in tessuto Arcadia 06 tortora. Rulli in pelle Soft 02 mastice. Biancheria da letto coordinata in cotone Provence 01 bianco e 07 grafite con profili nero.

Here and on the previous page: Rever bed, padded headboard and bed frame with removable covering in fabric Arcadia 06 tortora. Roll cushions in fabric Soft 02 mastice. Matching bed linen in cotton Provence 01 bianco and 07 grafite with profiles in nero.





REVER

Design Rodolfo Dordoni, 2016

Letto con testata imbottita in legno e derivati con dettaglio in metallo e imbottitura in poliuretano espanso a quote differenziate, prerivestimento in ovatta di poliestere. Rivestimento sfoderabile in tessuto o pelle. La parte frontale della testata presenta delle impunture con cucitura a cordoncino a leggero contrasto di colore.

Base letto imbottita in legno e derivati, imbottitura in poliuretano espanso a quote differenziate, prerivestimento in ovatta di poliestere. Rivestimento sfoderabile in tessuto o pelle.

Possibilità variante con fasce perimetrali testata e fasce interne base letto in pelle Nabuk in abbinamento a tessuto o pelle, in questa versione il rivestimento sarà sfoderabile ma non lavabile.

Coppia rulli opzionale con rivestimento sfoderabile in tessuto o pelle.

Predisposto per materassi:

l 1800-2000 x p 2000-2100

King size letto l 2110 x p 2430

materasso l 1930 x p 2030

Tipologia di rete:

- rete fissa a doghe flessibili
- reti anatomiche con movimento manuale
- rete ribaltabile con pistone per base con contenitore

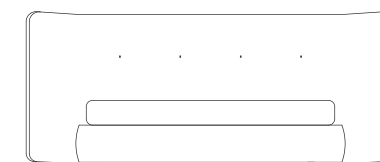

1975 - 2175
77 3/4" - 85 3/4"

2685 - 2885
105 3/4" - 113 1/2"

300
11 3/4"

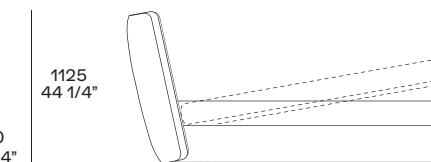

1125
44 1/4"

2395 - 2495
94 1/4" - 98 1/4"

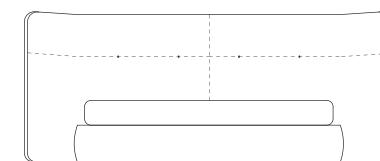

cuciture testata versione in pelle
headboard stitching leather version

Bed with padded headboard in wood and derivatives with detail in metal and padding in multi-density polyurethane foam, pre-covering in polyester wadding. Removable fabric or leather covering.

The front part of the headboard features backstitches in piping in a slightly contrasting colour.

Padded bed frame in wood and derivatives, padding in multi-density polyurethane foam, pre-covering in polyester wadding. Removable fabric or leather covering.

Possibility for variant with headboard perimeter bands and bed frame inner bands in Nabuk leather combined with fabric or leather, in this version the covering is removable but not washable.

Optional pair of roll cushions with removable fabric or leather covering.

For mattresses:

w 70 3/4"-78 3/4" x d 78 3/4"-82 3/4"

King size bed w 83 x d 95 3/4

for mattress w 76" x d 80"

Bedstead type:

- fixed with flexible slats
- anatomic with manual movement
- lifting bedstead with piston for bed frame with container

CHLOE

Progettato da Carlo Colombo per essere avvolgente come un abbraccio, Chloe è un letto contraddistinto dalla particolare testata che crea due piccole ali – una forma ripresa anche nella cassettera e nei comodini della stessa serie. Completamente imbottito, può essere profilato in gros-grain in tinta o a contrasto.

Designed by Carlo Colombo to be as enveloping as a hug, Chloe is a bed characterized by the particular headboard that creates two small wings – a shape also referenced by the dresser and nightstands of the same series. Completely upholstered, it can be profiled in grosgrain with the same colour or in contrast.







Qui, nelle pagine precedenti e in chiusura: letto Chloe, testata e base imbottite con rivestimento sfoderabile in tessuto Naxos 07 cemento, bordure gros-grain color acciaio. Biancheria da letto coordinata in cotone Provence 01 bianco con profilo nero. Quid boiserie in olmo nero. Comodini Chloe struttura esterna in cuoio 29 tortora e interna in brown nickel lucido, cassetti e top in olmo nero. Tavolino Baba in metallo verniciato oro lucido e piano in vetro oro. Poltrona Mad Chair rivestimento in tessuto sfoderabile Zante 7 oliva, con basamento girevole in brown nickel lucido. Tappeto Soft grigio. Tavolino Dama in laccato lucido visone. Tappeto Frame perla.

Here, on the previous pages and at the end: Chloe bed, padded headboard and bed frame with removable covering in fabric Naxos 07 cemento, piping in colour acciaio. Matching bed linen in cotton Provence 01 bianco with profile in nero. Quid wall panelling in black elm. Chloe night tables with outer structure in hide 29 tortora and inner structure in glossy brown nickel, drawers and top in black elm. Baba coffee table in glossy gold painted metal and glossy glass top. Mad Chair armchair with removable fabric covering in Zante 7 oliva, with swivel base in glossy brown nickel. Carpet Soft grigio. Dama coffee table in glossy lacquered visone. Carpet Frame perla.





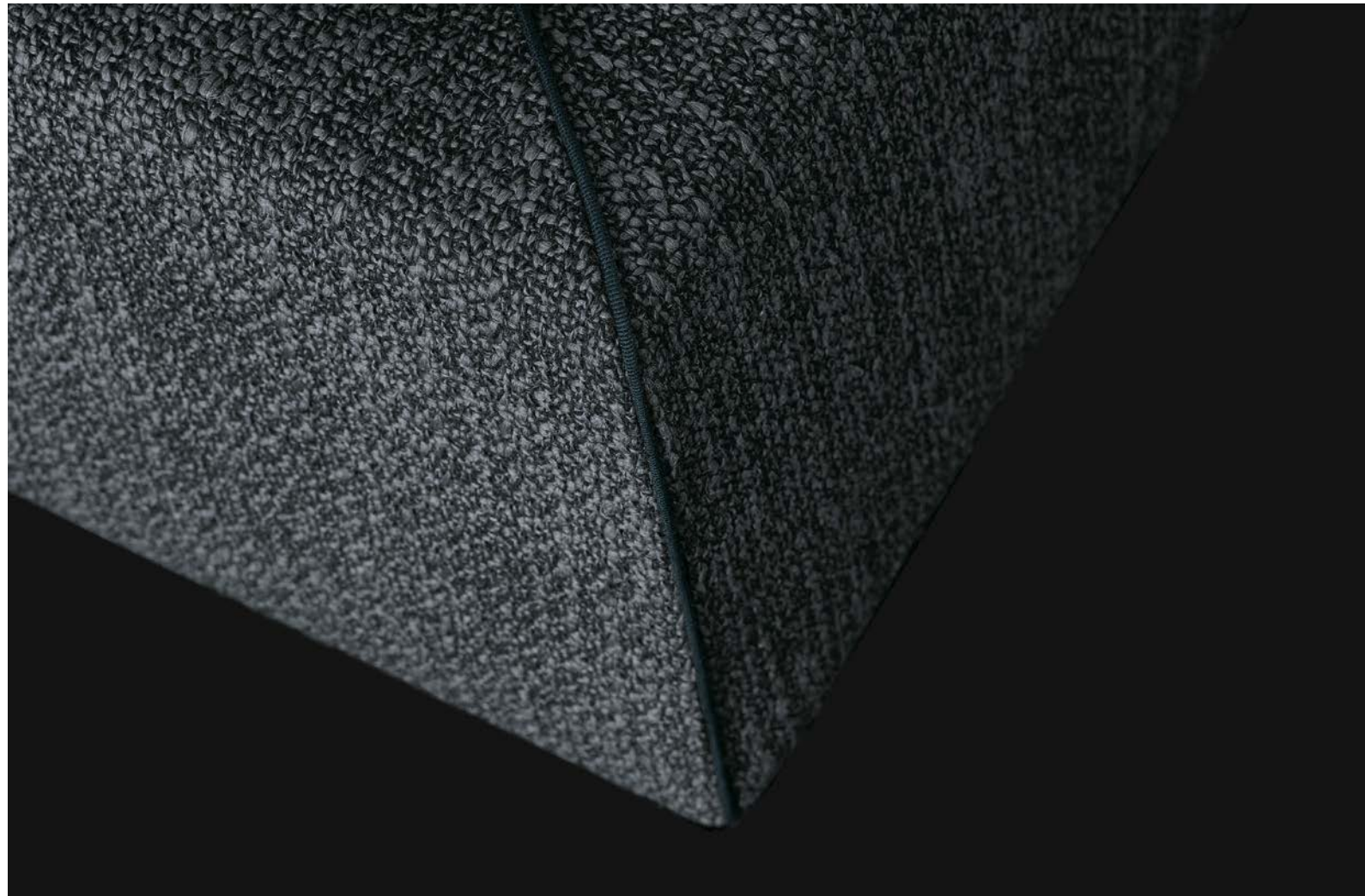

Qui e nella pagina precedente: letto Chloe, testata e base imbottite con rivestimento sfoderabile in tessuto Antea 10 grafite, bordure gros-grain color tempesta. Rulli in velluto Tebe 08 notte. Biancheria da letto coordinata in cotone Provence 03 ghiaccio e 07 grafite con profili bianco.

Here and on the previous page: Chloe bed, padded headboard and bed frame with removable covering in fabric Antea 10 grafite and piping in colour tempesta. Roll cushions in velvet Tebe 08 notte. Matching bed linen in cotton Provence 03 ghiaccio and 07 grafite with profiles in bianco.

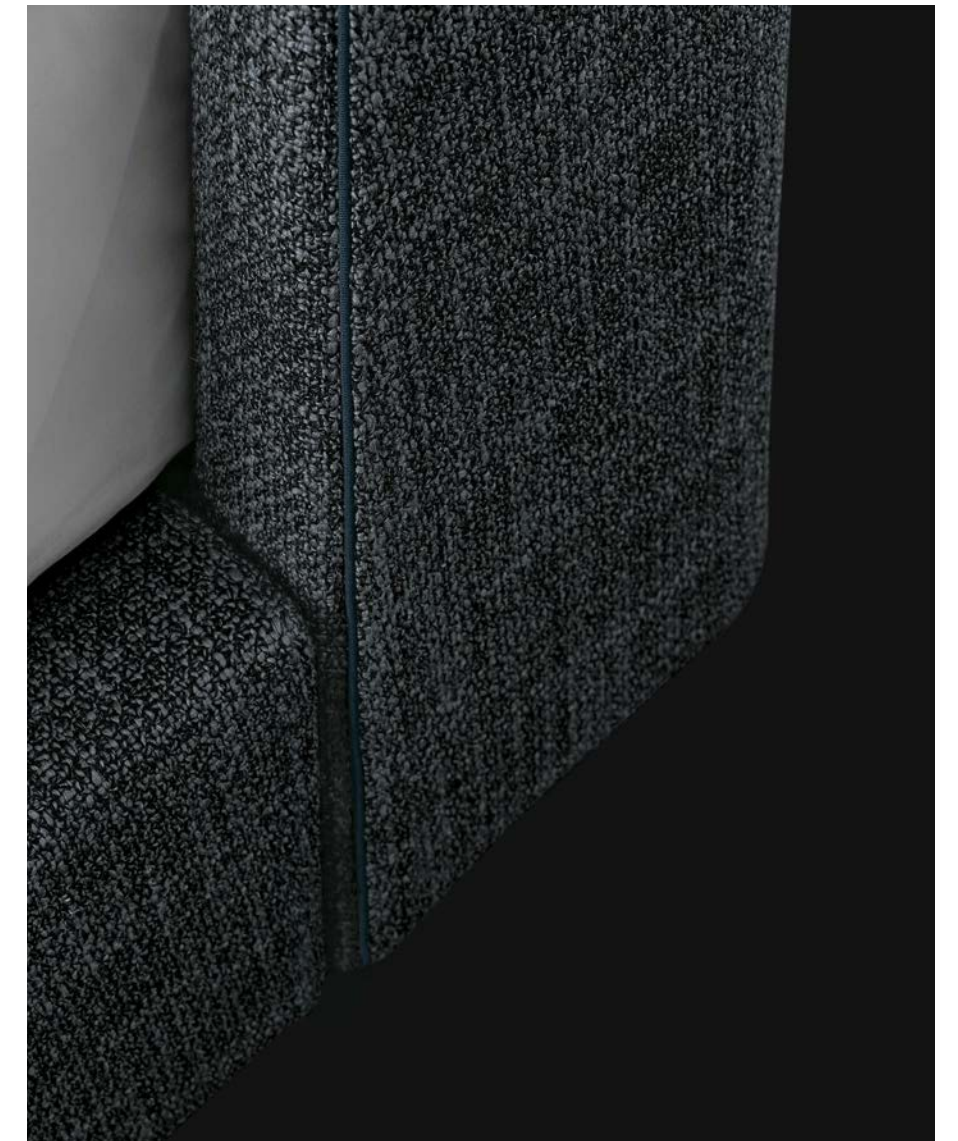



CHLOE

Design Carlo Colombo, 2017

Letto con testata imbottita in poliuretano flessibile stampato con telaio metallico, prriverestimento in ovatta di poliestere. Rivestimento sfoderabile in tessuto o pelle. Base letto imbottita in legno e derivati, imbottitura in poliuretano espanso a quote differenziate, prriverestimento in ovatta di poliestere. Rivestimento sfoderabile in tessuto o pelle.

Cucitura normale o bordure gros-grain nei diversi colori da campionario (escluso rivestimento in pelle e velluto). Coppia rulli opzionale con rivestimento sfoderabile in tessuto o pelle.

Predisposto per materassi:
l 1600-1800 x p 2000-2100

Tipologia di rete:

- rete fissa a doghe flessibili
- reti anatomiche con movimento manuale
- rete ribaltabile con pistone per base con contenitore

Bed with padded headboard in moulded flexible polyurethane foam with metal frame, pre-covering in polyester wadding. Removable fabric or leather covering. Padded bed frame in wood and derivatives, padding in multi-density polyurethane foam, pre-covering in polyester wadding. Removable fabric or leather covering.

Normal stitching or piping in the colours as per sample book (except leather and velvet covering). Optional pair of roll cushions with removable fabric or leather covering.

For mattresses:
w 63"-70 3/4" x d 78 3/4"-82 3/4"

Bedstead type:

- fixed with flexible slats
- anatomic with manual movement
- lifting bedstead with piston for bed frame with container

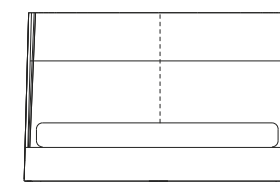
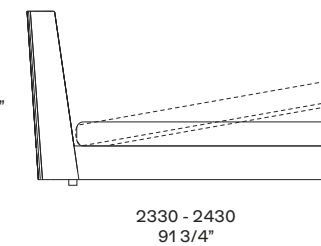
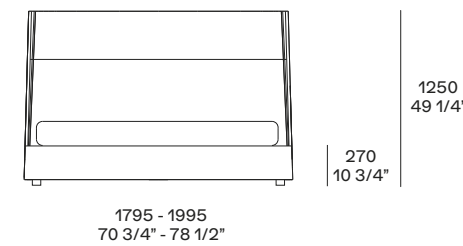

cuciture testata versione in pelle
headboard stitching leather version



DREAM

Marcel Wanders disegna un letto da sogno, accostando a una base dalle linee arrotondate ed essenziali un sistema di pannelli imbottiti, completamente personalizzabile. I pannelli, rivestiti singolarmente in tessuto o pelle, fungono da testata, ma anche da boiserie.

Marcel Wanders designs a dream bed, combining a base with rounded and minimalistic lines with a completely customizable system of padded panels. The panels, individually upholstered in fabric or leather, act as a headboard, but also as panelling.







Qui e nelle pagine precedenti: letto Dream con pannellatura a muro, rivestimento sfoderabile in tessuto Skyros 02 sabbia. Base letto rivestimento sfoderabile in pelle Soft 02 mastice. Biancheria da letto coordinata in cotone Provence 01 bianco con profilo polvere e 08 polvere con profilo bianco. Tavolino Ilda con struttura in fusione d'ottone bronzata e piano in lapislazzulo blu. Poltrone Santa Monica in pelle sfoderabile Nabuk 02 tortora. Tavolino Soori in metallo finitura bronzo anticato. Scrivania Mathieu in brown nickel lucido, piano in rovere spessart con inserto in cuoio 29 tortora. Sedia Guest in pelle non sfoderabile Soft 10 prugna. Armadio Senzafine Bangkok, ante in cuoio 28 avorio.

Here and on the previous pages: Dream bed with wall panelling, removable covering in fabric Skyros 02 sabbia. Bed frame with removable covering in leather Soft 02 mastice. Matching bed linen in cotton Provence 01 bianco with profile in polvere and 08 polvere with profile in bianco. Ilda coffee table with structure in bronzed brass casting and top in blue lapis lazuli. Santa Monica armchair in removable leather Nabuk 02 tortora. Soori coffee table in antique bronze finished metal. Mathieu desk in glossy brown nickel, top in spessart oak with insert in hide 29 tortora. Guest chair in non-removable leather Soft 10 prugna. Senzafine Bangkok wardrobe, doors in hide 28 avorio.

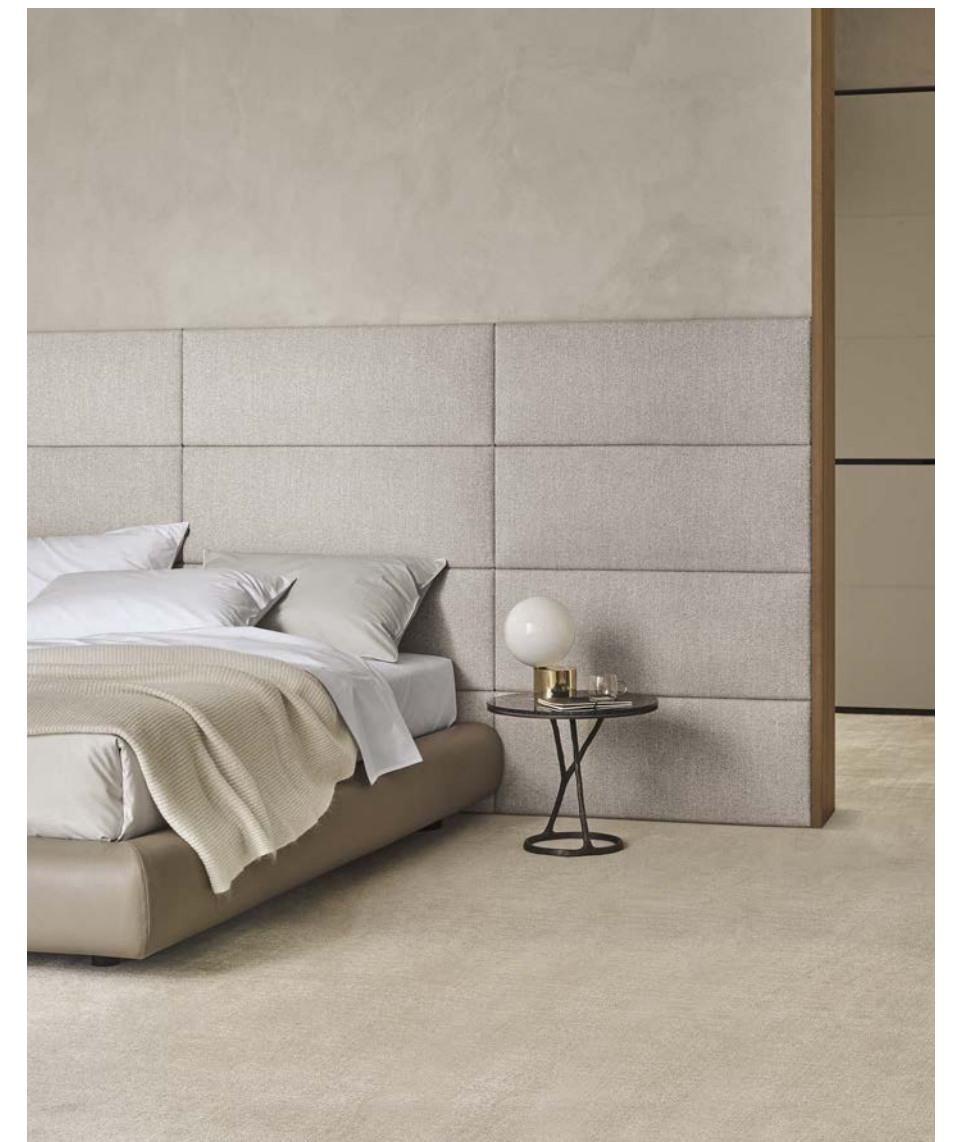





Qui e nella pagina precedente: letto Dream con testata e base imbottite, rivestimento sfoderabile in tessuto Naxos 17 corda. Biancheria da letto coordinata in cotone Provence 03 ghiaccio con profilo nero e 06 roccia con profilo roccia. Nella pagina successiva: letto Dream con pannellatura a muro, rivestimento sfoderabile in tessuto Micene 08 argilla. Base letto rivestimento sfoderabile in pelle Silk 11 cognac. Biancheria da letto coordinata in cotone Provence 01 bianco con profilo bianco e 08 polvere con profilo bianco.

Here and on the previous page: Dream bed with padded headboard and bed frame, removable covering in fabric Naxos 17 corda. Matching bed linen in cotton Provence 08 polvere with profile in nero and 06 roccia with profile in roccia. On the next page: Dream bed with wall panelling, removable covering in fabric Micene 08 argilla. Bed frame with removable covering in leather Silk 11 cognac. Matching bed linen in cotton Provence 01 bianco with profile in bianco and 08 polvere with profile in bianco.





Qui e nelle pagine successive: letto Dream con pannellatura a muro, rivestimento sfoderabile in pelle Special 40 ardesia e velluto Persia 1404 carbone. Base letto rivestimento sfoderabile in pelle Special 40 ardesia. Biancheria da letto coordinata in cotone Provence 01 bianco e 04 tortora con profilo nero. Comodini Dream in laccato lucido moka. Poltrone Gaston rivestimento non sfoderabile in pelle Soft 13 carbone, struttura verniciata lucido carbone. Tappeto Soft.

Here and on the next pages: Dream bed with wall panelling, removable covering in leather Special 40 ardesia and velvet Persia 1404 carbone. Bed frame with removable covering in leather Special 40 ardesia. Matching bed linen in cotton Provence 01 bianco and 04 tortora with profile in nero. Dream night tables in glossy lacquered moka. Gaston armchair with non-removable covering in leather Soft 13 carbone, carbone glossy painted structure. Carpet Soft.

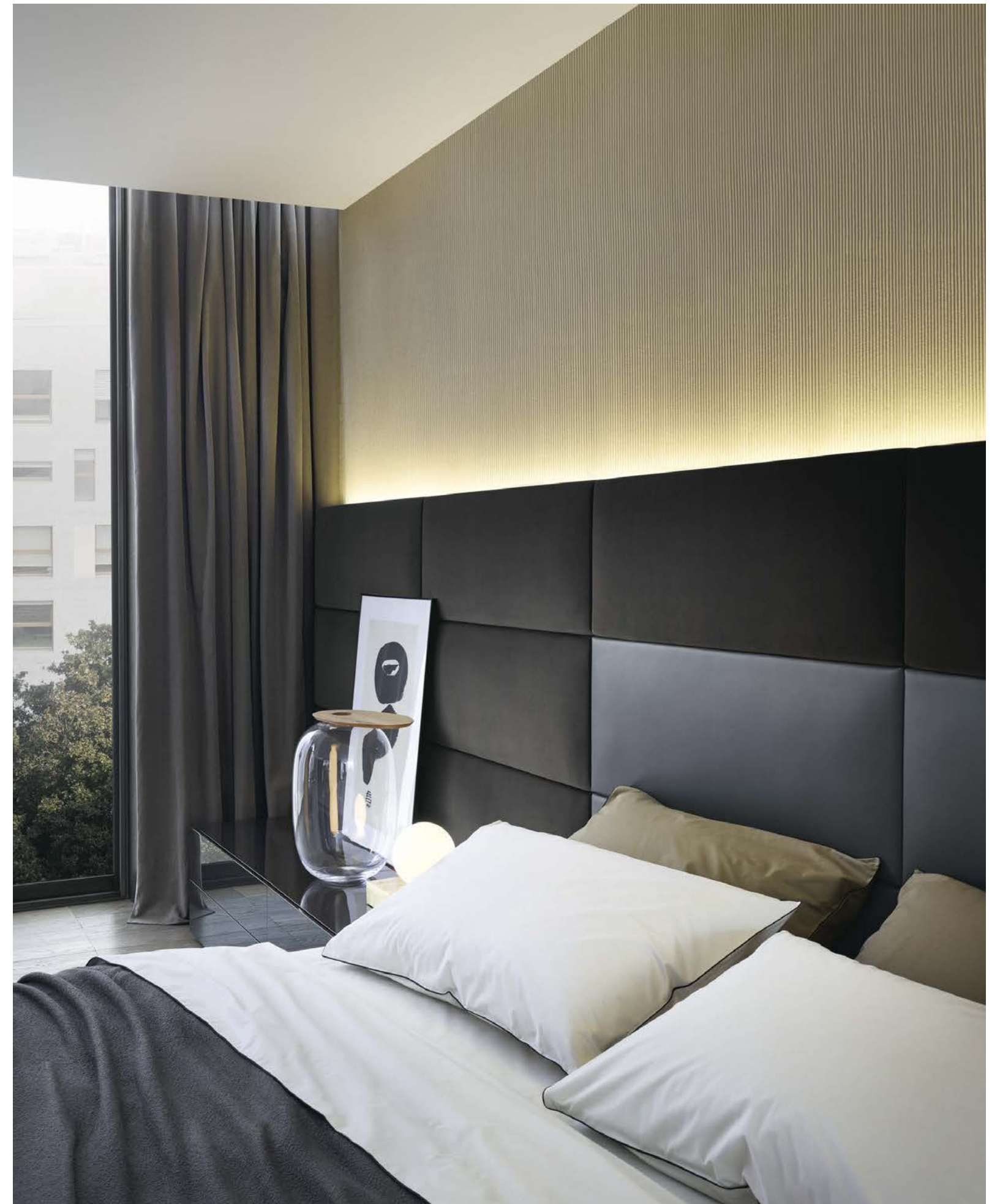





DREAM

Design Marcel Wanders, 2006

Letto disponibile in tre varianti, con pannellatura a muro, con testata o base letto imbottito su quattro lati.
 Base letto, struttura pannello di particelle di legno imbottito, rivestimento sfoderabile in tessuto o pelle.
 Pannellatura comprensiva di ferramenta per fissaggio a muro, con possibilità di predisposizione gruppo interruttore/prese elettriche. Pannelli di particelle di legno e poliuretano flessibile stampato con rivestimento sfoderabile in tessuto o pelle.
 Testata imbottita in poliuretano flessibile stampato con struttura metallica, rivestimento sfoderabile in tessuto o pelle.
 Coppia rulli opzionale con rivestimento sfoderabile in tessuto o pelle.

Pannelli a muro:
 l 690-955-1037 - h 370

Predisposto per materassi:
 l 1600-1800 x p 2000-2100

Tipologia di rete:
 - rete fissa a doghe flessibili
 - reti anatomiche con movimento manuale
 - rete ribaltabile con pistone per base con contenitore (escluso versione base letto imbottita su quattro lati)

Bed available in three versions, with wall panelling, with headboard or bed frame with padding on all four sides.
 Bed frame, padded particleboard structure, removable fabric or leather covering.
 Pannelling including hardware for wall fixing, with the possibility of switch/ electric sockets group set-up.
 Particleboard and flexible moulded polyurethane foam with removable fabric or leather covering.
 Headboard with moulded polyurethane foam padding and metal structure, removable fabric or leather covering.
 Optional pair of roll cushions with removable fabric or leather covering.

Wall panels:
 w 27 1/4"-37 1/2"-40 3/4" - h 14/ 1/2"

For mattresses:
 w 63"-70 3/4" x d 78 3/4"-82 3/4"

Bedstead type:
 - fixed with flexible slats
 - anatomic with manual movement
 - lifting bedstead with piston for bed frame with container (except bed frame with padding on all four sides)

Base letto imbottita 4 lati Bed frame with padding on 4 sides

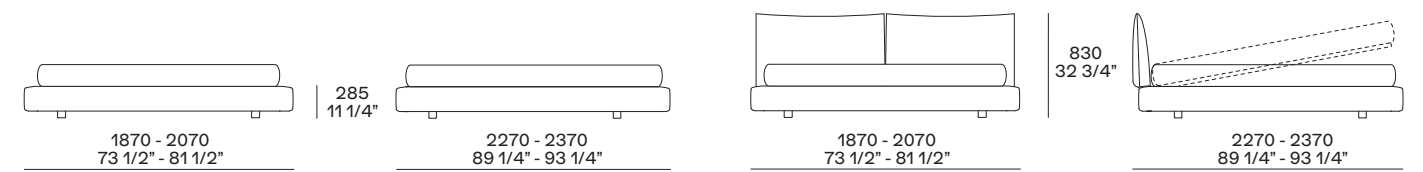

Base letto con testata Bed frame with headboard

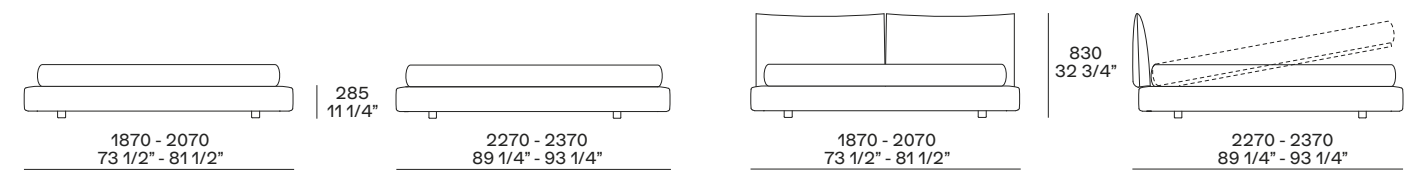

Base letto con pannellatura Bed frame with panelling

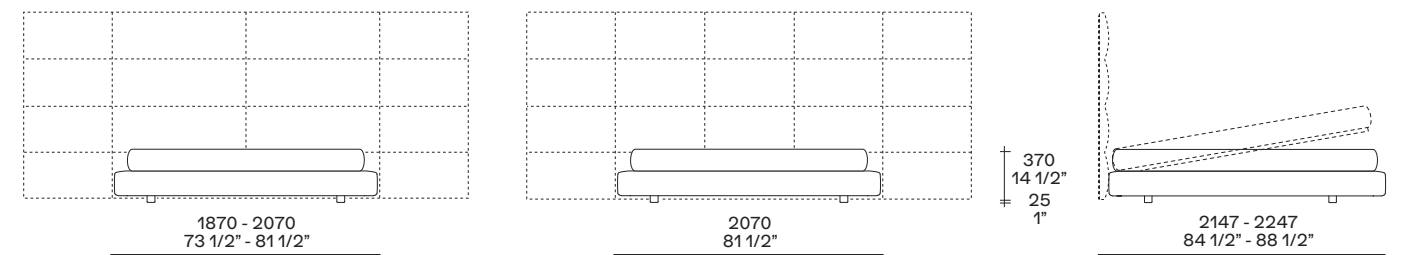

due pannelli | 955 per materasso | 1600
 due pannelli | 1037 per materasso | 1800
 two panels | 955 for mattress | 1600
 two panels | 1037 for mattress | 1800

tre pannelli | 690 per materasso | 1800
 three panels | 690 for mattress | 1800

ONDA



Moderno e rigoroso, il letto Onda di Paolo Piva rappresenta un unicum della collezione. Gambe leggere in metallo sorreggono una struttura molto caratterizzata, un tutt'uno che fa da base e testata in pelle lavorata a capitoné per un vero primo attore dello spazio notte.

Modern and rigorous, the Onda bed by Paolo Piva is unique in the collection. Light metal legs support a very distinctive structure, a whole that acts as base and headboard in capitoné leather for a true leading actor of the night space.

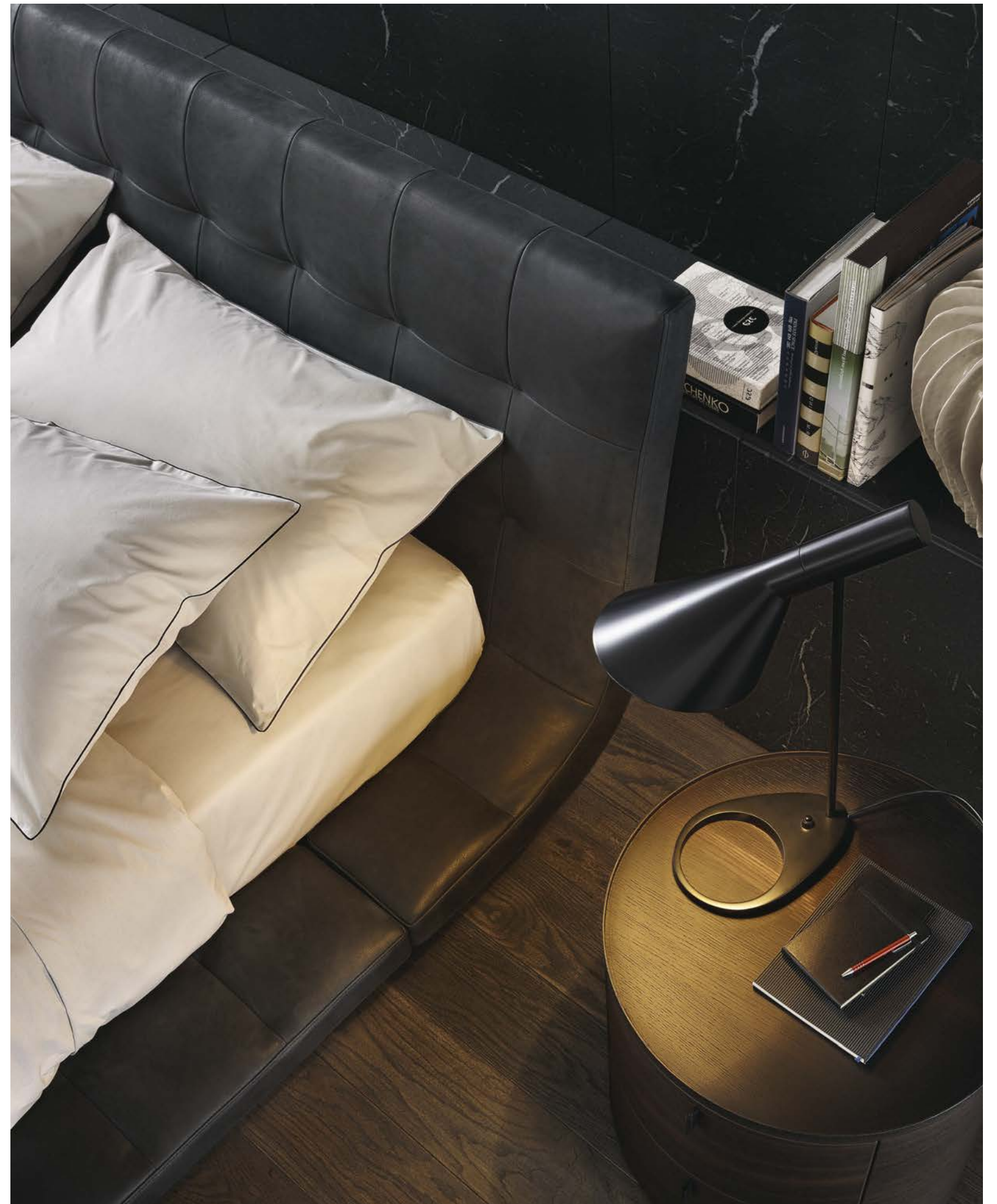





Nelle pagine precedenti: letto Onda, rivestimento non sfoderabile con lavorazione capitonné in pelle Invecchiata 880 nero, piedini in brown nickel opaco. Biancheria da letto coordinata in cotone Provence 08 polvere con profilo nero. Comodino Onda in rovere spessart. Qui e nella pagina successiva: letto Onda, rivestimento non sfoderabile con lavorazione capitonné in pelle Silk 10 terracotta, piedini in brown nickel opaco. Biancheria da letto coordinata in cotone Provence 01 bianco e 08 polvere con profili bianco. Nella pagina in chiusura: letto Onda, rivestimento non sfoderabile con lavorazione capitonné in pelle Special 14 nero. Comodino Onda in noce c.

On the previous pages: Onda bed, non-removable covering with quilted manufacturing in leather Invecchiata 880 nero, feet in mat brown nickel. Matching bed linen in cotton Provence 08 polvere with profile in nero. Onda night table in spessart oak. Here and on the next page: Onda bed, non-removable covering with quilted manufacturing in leather Silk 10 terracotta, feet in mat brown nickel. Matching bed linen in cotton Provence 01 bianco and 08 polvere with profiles in bianco. On the page at the end: Onda bed, non-removable covering with quilted manufacturing in leather Special 14 nero. Onda night table in walnut c.

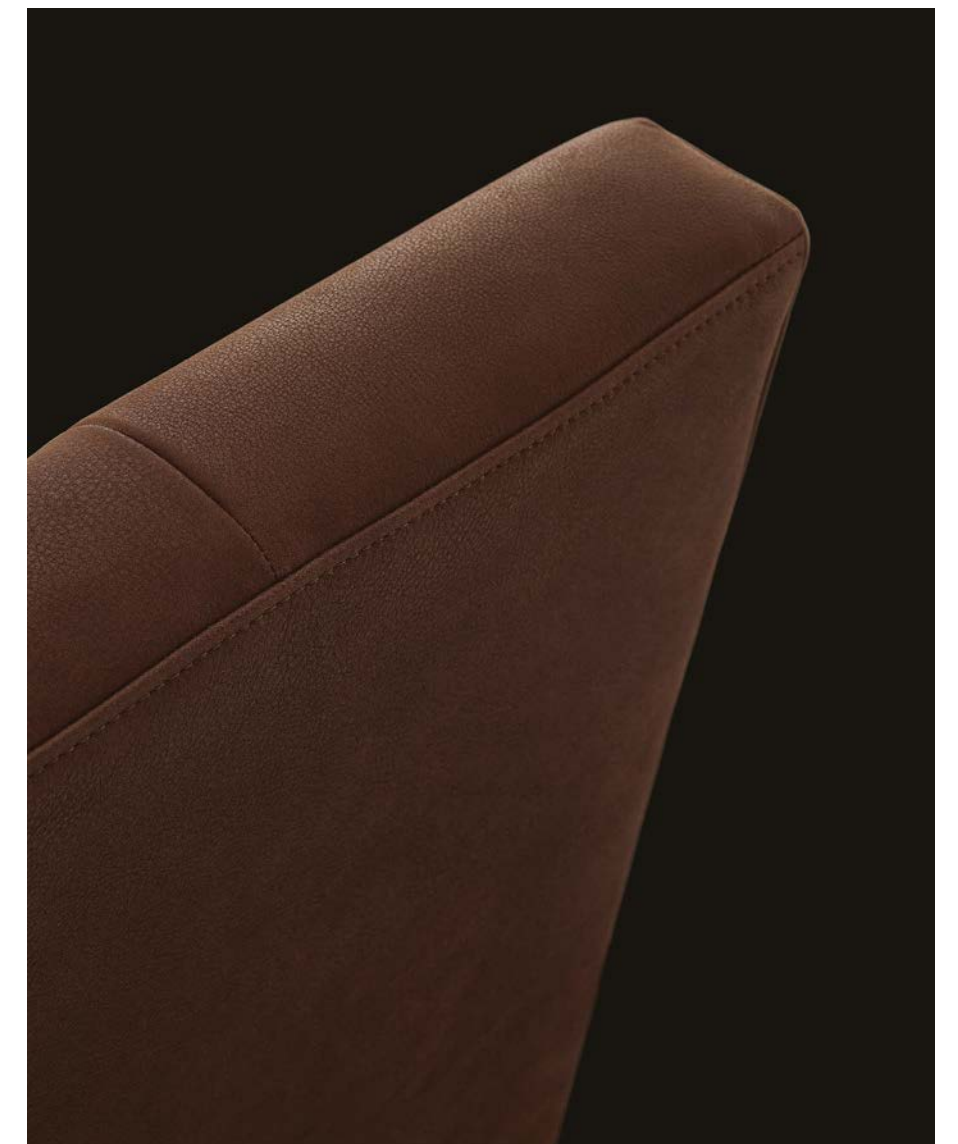





ONDA

Design Paolo Piva, 2007

Letto con struttura metallica e imbottitura in poliuretano flessibile stampato. Rivestimento non sfoderabile in pelle con lavorazione capitonné. Piedini brown nickel opaco. Coppia rulli opzionale con rivestimento sfoderabile in tessuto o pelle.

Predisposto per materassi:
l 1600-1800 x p 2000

Tipologia di rete:

- rete fissa a doghe flessibili
- reti anatomiche con movimento manuale

Bed with metal structure and padding in moulded flexible polyurethane foam. Non-removable covering in leather with quilted manufacturing. Mat brown nickel feet. Optional pair of roll cushions with removable fabric or leather covering.

For mattresses:
w 63"-70 3/4" x d 78 3/4"

Bedstead type:

- fixed with flexible slats
- anatomic with manual movement

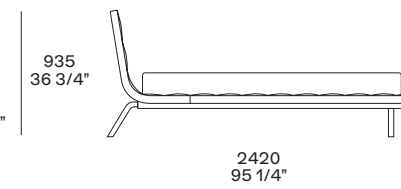
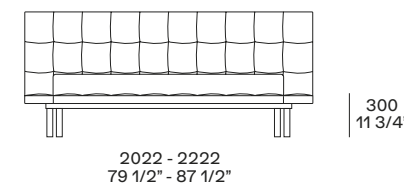

LAZE

Un letto imbottito rigoroso e importante, design di Rodolfo Dordoni, che punta sulla morbidezza e sulle sensazioni tattili del rivestimento, disponibile in tessuto o pelle. La testata, molto alta e leggermente inclinata, è segnata da cuciture che ne accentuano la morbidezza.

A rigorous and important upholstered bed, designed by Rodolfo Dordoni, which focuses on the softness and tactile sensations of the upholstery, available in fabric or leather. The headboard, very tall and slightly inclined, is marked by seams that accentuate its softness.







Qui, nelle pagine precedenti e in chiusura: letto Laze, testata e base imbottite con rivestimento sfoderabile in pelle Nabuk 02 tortora. Biancheria da letto coordinata in cotone Provence 01 bianco, 08 polvere e 06 roccia con profilo nero. Comodino Onda in rovere spessart con piano in marmo calacatta oro lucido. Poltrona Soori Highline rivestimento non sfoderabile in velluto Persia 2006 prugna e bordure gros-grain nero, struttura in rovere spessart. Armadio Senzafine New Entry in laccato opaco visone.

Here, on the previous pages and at the end: Laze bed, padded headboard and bed frame with removable covering in leather Nabuk 02 tortora. Matching bed linen in cotton Provence 01 bianco, 08 polvere and 06 roccia with profile in nero. Onda night table in spessart oak with glossy calacatta oro marble top. Soori Highline armchair with non-removable covering in velvet Persia 2006 prugna and piping in nero, structure in spessart oak. Senzafine New Entry wardrobe in mat lacquered visone.





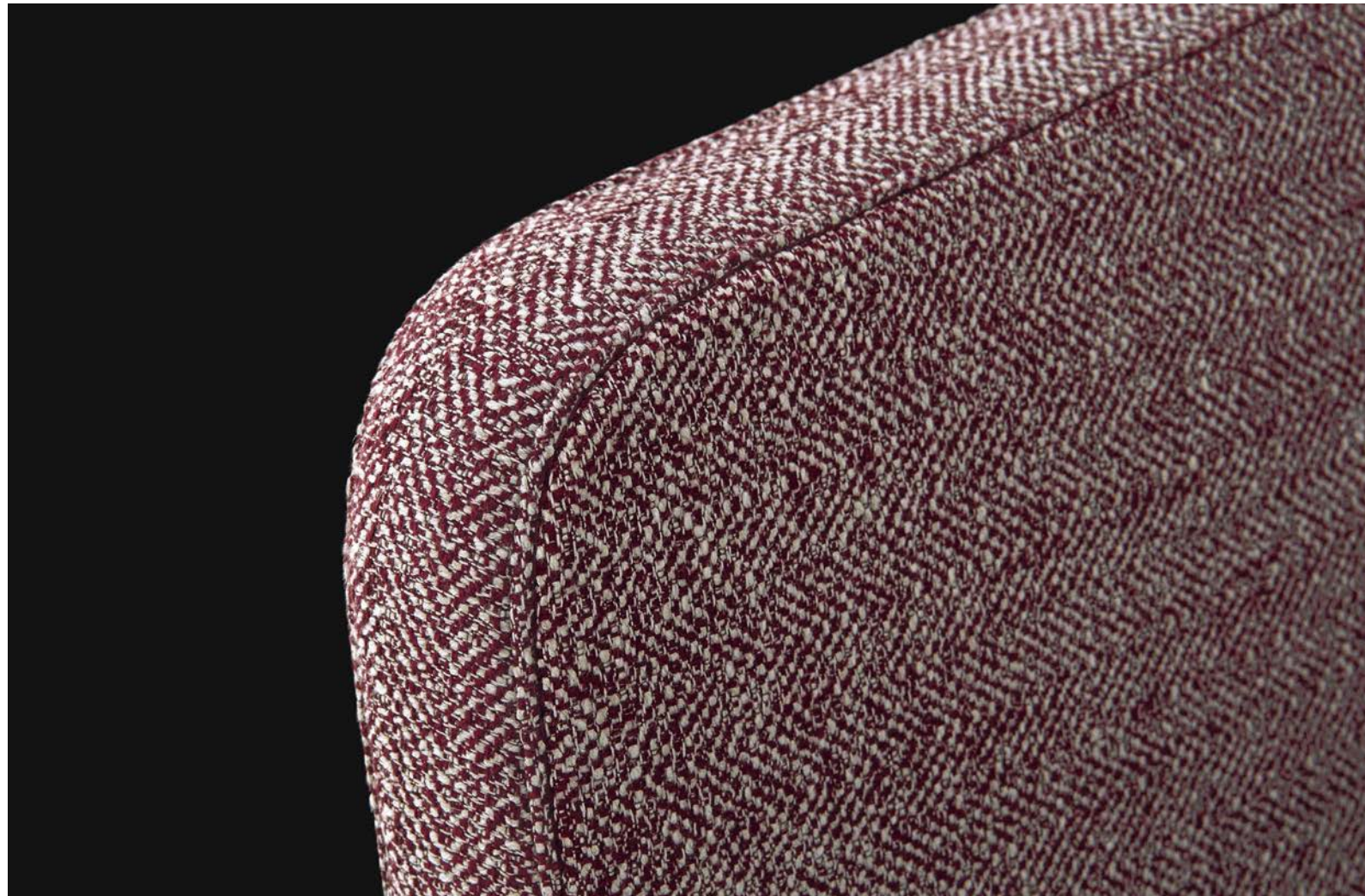

Qui e nella pagina precedente: letto Laze, testata e base imbottite con rivestimento sfoderabile in tessuto Skyros 10 bordeaux. Rulli in tessuto Naxos 32 bordeaux. Biancheria da letto coordinata in cotone Provence 03 ghiaccio e 07 grafite con profili bianco.

Here and on the previous page: Laze bed, padded headboard and bed frame with removable covering in fabric Skyros 10 bordeaux. Roll cushions in fabric Naxos 32 bordeaux. Matching bed linen in cotton Provence 03 ghiaccio and 07 grafite with profiles in bianco.

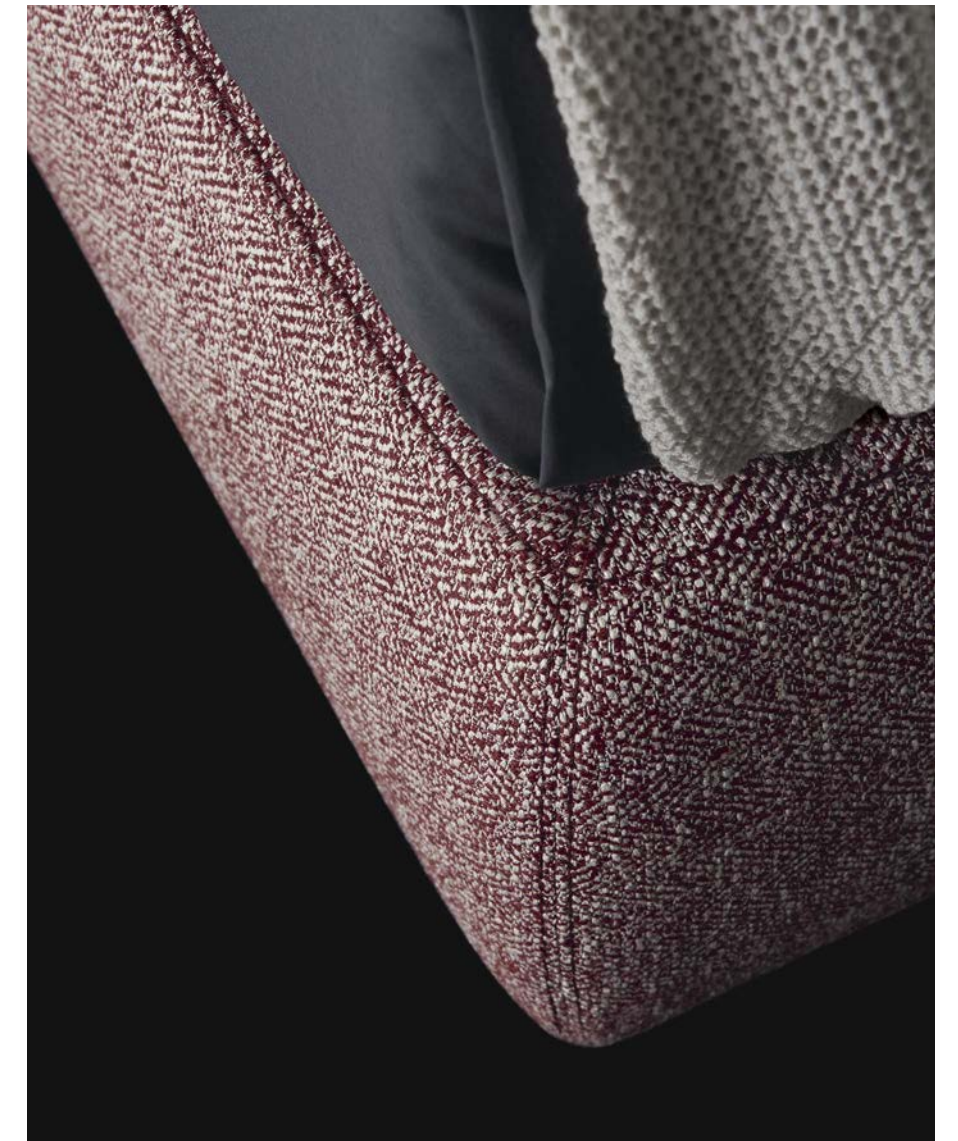



LAZE

Design Rodolfo Dordoni, 2014

Letto con testata imbottita in poliuretano flessibile stampato con telaio metallico, prerivestimento in ovatta di poliestere. Rivestimento sfoderabile in tessuto o pelle. Retro testata disponibile in due versioni, in tela nera e in tessuto o pelle nella stessa finitura della parte frontale. Base letto imbottita in legno e derivati, imbottitura in poliuretano espanso a quote differenziate, prerivestimento in ovatta di poliestere. Rivestimento sfoderabile in tessuto o pelle. Coppia rulli opzionale con rivestimento sfoderabile in tessuto o pelle.

Predisposto per materassi:

l 1600-1800 x p 2000-2100
King size letto l 2080 x p 2230
 materasso l 1930 x p 2030

Tipologia di rete:

- rete fissa a doghe flessibili
- reti anatomiche con movimento manuale
- rete ribaltabile con pistone per base con contenitore

Bed with padded headboard in moulded flexible polyurethane foam with metal frame, pre-covering in polyester wadding. Removable fabric or leather covering. Headboard backside available in two versions, in black canvas and in fabric or leather in the same finish as the front part. Padded bed frame in wood and derivatives, padding in multi-density polyurethane foam, pre-covering in polyester wadding. Removable fabric or leather covering. Optional pair of roll cushions with removable fabric or leather covering.

For mattresses:

w 63"-70 3/4" x d 78 3/4"-82 3/4"
King size bed w 82" x d 87 3/4"
 for mattress w 76" x d 80"

Bedstead type:

- fixed with flexible slats
- anatomic with manual movement
- lifting bedstead with piston for bed frame with container

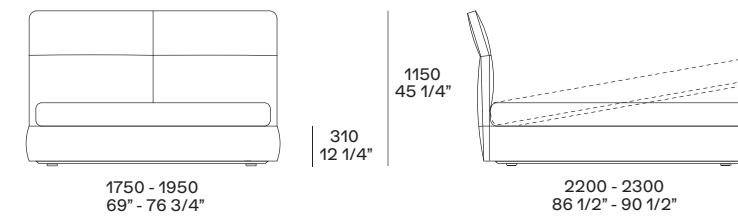



ARCA

Arca è un sistema versatile, che si personalizza affiancando alla base tessile due tipologie di testata: più romantica quella trapuntata, più essenziale quella liscia. Una proposta firmata Poliform che interpreta stili diversi, disponibile anche in versione singola.

Arca is a versatile system that you can customize by adding two types of headboard to the textile base: more romantic the quilted one, more minimalistic the smooth one. An offer designed by Poliform that interprets different styles, also available in single version.

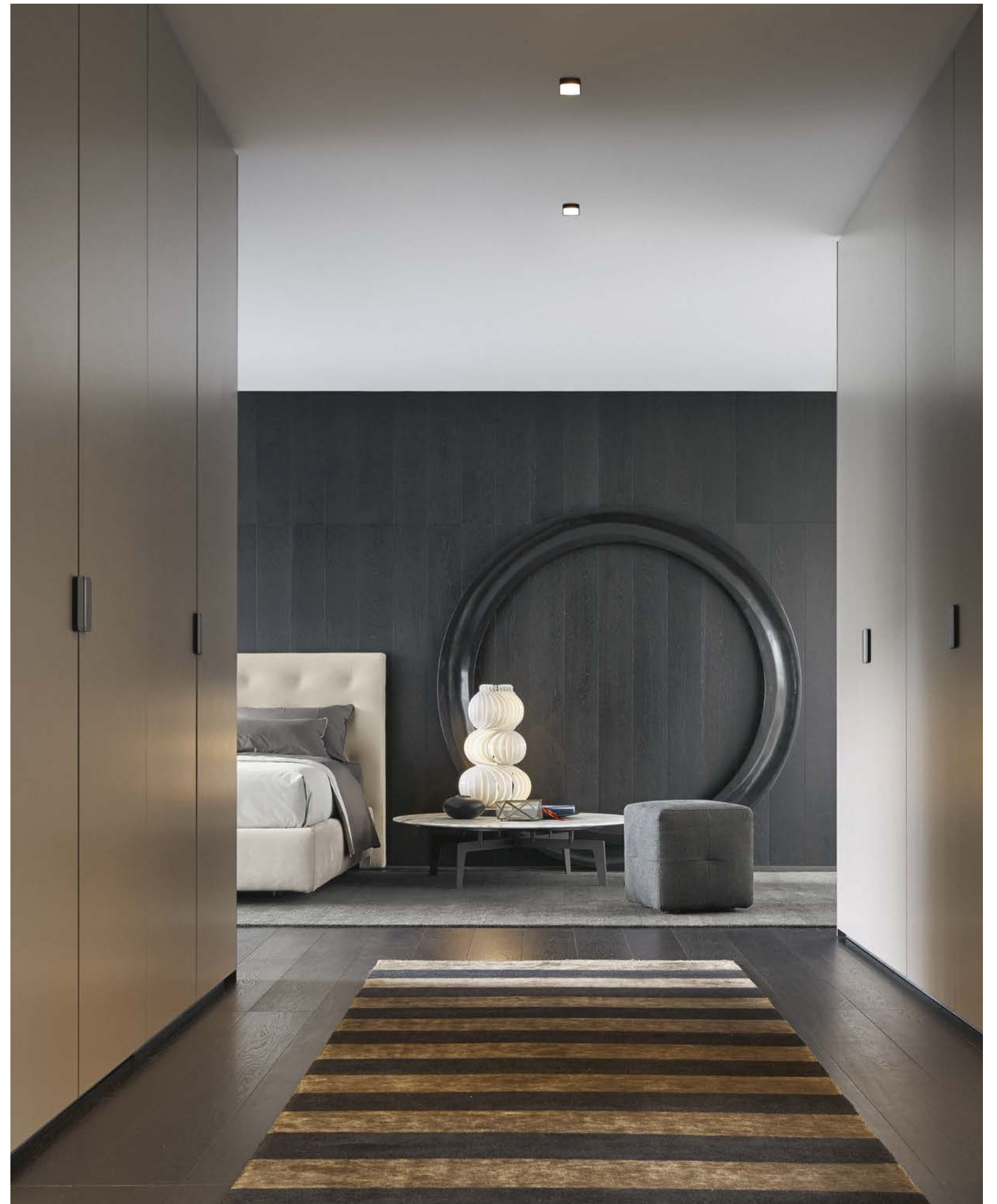





Nelle pagine precedenti e in chiusura: letto Arca con testata imbottita trapuntata. Base letto e testata con rivestimento sfoderabile in pelle Nabuk 01 latte. Biancheria da letto coordinata in cotone Provence 06 roccia con profilo bianco e nero e 03 ghiaccio con profilo bianco. Tavolino Tribeca in brown nickel opaco con piano in marmo calacatta oro lucido. Comodino You in rovere spessart. Pouf Onda in tessuto sfoderabile Arcadia 09 grafite. Armadio Senzafine New Entry in laccato opaco arena. Tappeto Stripes. Qui e nella pagina successiva: letto Arca con testata imbottita trapuntata. Base letto e testata con rivestimento sfoderabile in tessuto Antea 05 terra di siena. Rulli in pelle Silk 10 terracotta. Biancheria da letto coordinata in cotone Provence 01 bianco con profilo polvere e 08 polvere con profilo bianco.

On the previous pages and at the end: Arca bed with quilted padded headboard. Bed frame and headboard with removable covering in leather Nabuk 01 latte. Matching bed linen in cotton Provence 06 roccia with profile in bianco and nero and 08 polvere with profile in bianco. Tribeca coffee table in mat brown nickel with glossy calacatta oro marble top. You night table in spessart oak. Onda pouf in removable fabric Arcadia 09 grafite. Senzafine New Entry wardrobe in mat lacquered arena. Carpet Stripes. Here and on the next page: Arca bed with quilted padded headboard. Bed frame and headboard with removable covering in fabric Antea 05 terra di siena. Roll cushions in leather Silk 10 terracotta. Matching bed linen in cotton Provence 01 bianco with profile in polvere and 08 polvere with profile in bianco.







Qui e nella pagina successiva: letto singolo Arca, testata e base imbottite con rivestimento sfoderabile in tessuto Caleo 11 navy. Rullo in tessuto Persia 54 prussia. Biancheria da letto coordinata in cotone Provence 01 bianco con profilo roccia e 06 roccia con profilo bianco.

Here and on the next page: Arca single bed, padded headboard and bed frame with removable covering in fabric Caleo 11 navy. Roll cushions in fabric Persia 54 prussia. Matching bed linen in cotton Provence 01 bianco with profile in roccia and 06 roccia with profile in bianco.







ARCA

Design R&D Poliform, 2003

Letto disponibile in tre varianti, con testata imbottita, con testata imbottita trapuntata o base letto imbottito su quattro lati.
 Base letto e testata, struttura pannello di particelle di legno imbottito.
 Rivestimento sfoderabile in tessuto o pelle.
 Retro testate disponibile in due versioni, in tela nera e in tessuto o pelle nella stessa finitura della parte frontale.
 Coppia rulli opzionale con rivestimento sfoderabile in tessuto o pelle.

Predisposto per materassi:
 l 1000-1400-1600-1800-2000 x
 p 2000-2100

Queen size con testata imbottita trapuntata, letto l 1778 x p 2190
 materasso l 1525 x p 2030

King size con testata imbottita trapuntata, letto l 2184 x p 2190
 materasso l 1930 x p 2030

Tipologia di rete:

- rete fissa a doghe flessibili
- reti anatomiche con movimento manuale
- rete ribaltabile con pistone per base con contenitore (escluso materasso l 2000)

Bed available in three versions, with padded headboard, with quilted padded headboard or bed frame with padding on all four sides.
 Bed frame and headboard, padded particleboard structure.
 Removable fabric or leather covering.
 Headboard backside available in two versions, in black canvas and in fabric or leather in the same finish as the front part.
 Optional pair of roll cushions with removable fabric or leather covering.

For mattresses:

w 39 1/4"-55"-63"-70 3/4"-78 3/4" x
 d 78 3/4"-82 3/4"

Queen size with quilted upholstered headboard, bed w 70" x d 86 1/4"
 for mattress w 60" x d 80"

King size with quilted upholstered headboard, bed w 86" x d 86 1/4"
 for mattress w 76" x d 80"

Bedstead type:

- fixed with flexible slats
- anatomic with manual movement
- lifting bedstead with piston for bed frame with container (except mattress w 78 3/4")

Base letto imbottita 4 lati Bed frame with padding on 4 sides

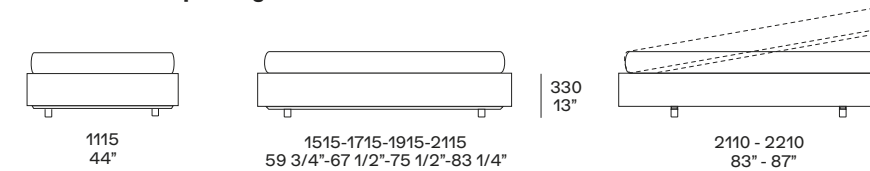

Base letto con testata imbottita Bed frame with padded headboard

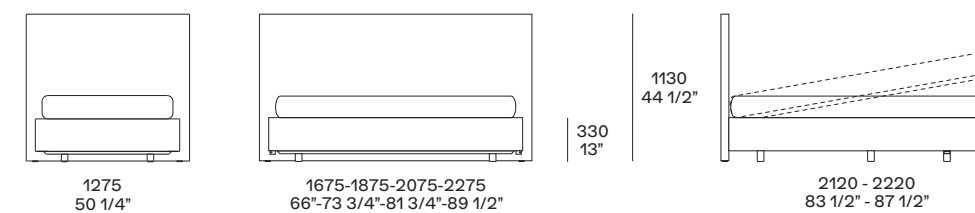

Base letto con testata imbottita trapuntata Bed frame with quilted padded headboard

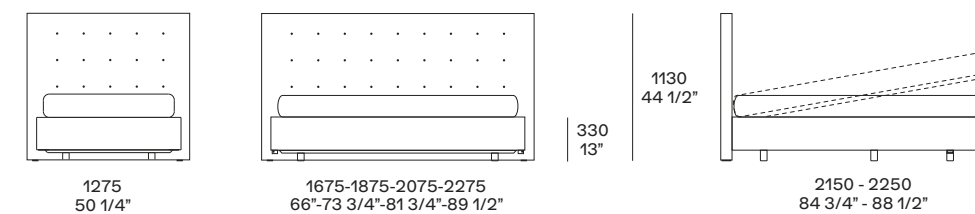

STORAGE UNITS

Comodini e cassettiere sono progettati per accompagnare i letti della collezione. Carlo Colombo, Emmanuel Gallina e Marcel Wanders coordinano i complementi con i letti delle serie omonime, creando dei veri e propri sistemi notte. Rodolfo Dordoni reinterpreta gli arredi della zona giorno in funzione della camera da letto e D&T riscrivono l'arte dell'ebanisteria in chiave contemporanea. Poliform invece mette a punto due serie di complementi dall'estetica universale, giusta in ogni contesto, perfetta da abbinare a tutti i letti della collezione.

Night tables and chests of drawers are designed to accompany the beds in the collection. Carlo Colombo, Emmanuel Gallina, and Marcel Wanders coordinate the complements with the beds of the homonymous series, creating true night systems. Rodolfo Dordoni reinterprets the furnishings of the day area for the bedroom, and D&T rewrite the art of cabinetry with a contemporary approach. Poliform instead develops two sets of complements with a universal style, fitting every context, perfect to combine with all the beds in the collection.

STORAGE UNITS

KELLY	161
ONDA	177
ABBINABILI	191
DREAM	205
CHLOE	219
YOU	231
GIÒ	245



KELLY

Per accompagnare il letto Kelly, Emmanuel Gallina disegna una serie di complementi dalle linee sinuose, delicate ed eleganti. Il comodino e la cassettera, disponibili con piedini o in appoggio a terra, si riconoscono per le forme arrotondate. La cassettera in appoggio è impreziosita da un piccolo piano portaoggetti in vetro.

To accompany the Kelly bed, Emmanuel Gallina designs a series of complements with sinuous, delicate, and elegant lines. The night table and the chest of drawers, available with or without feet, can be recognized by their rounded shapes. The chest of drawers without feet is embellished by a small glass shelf.

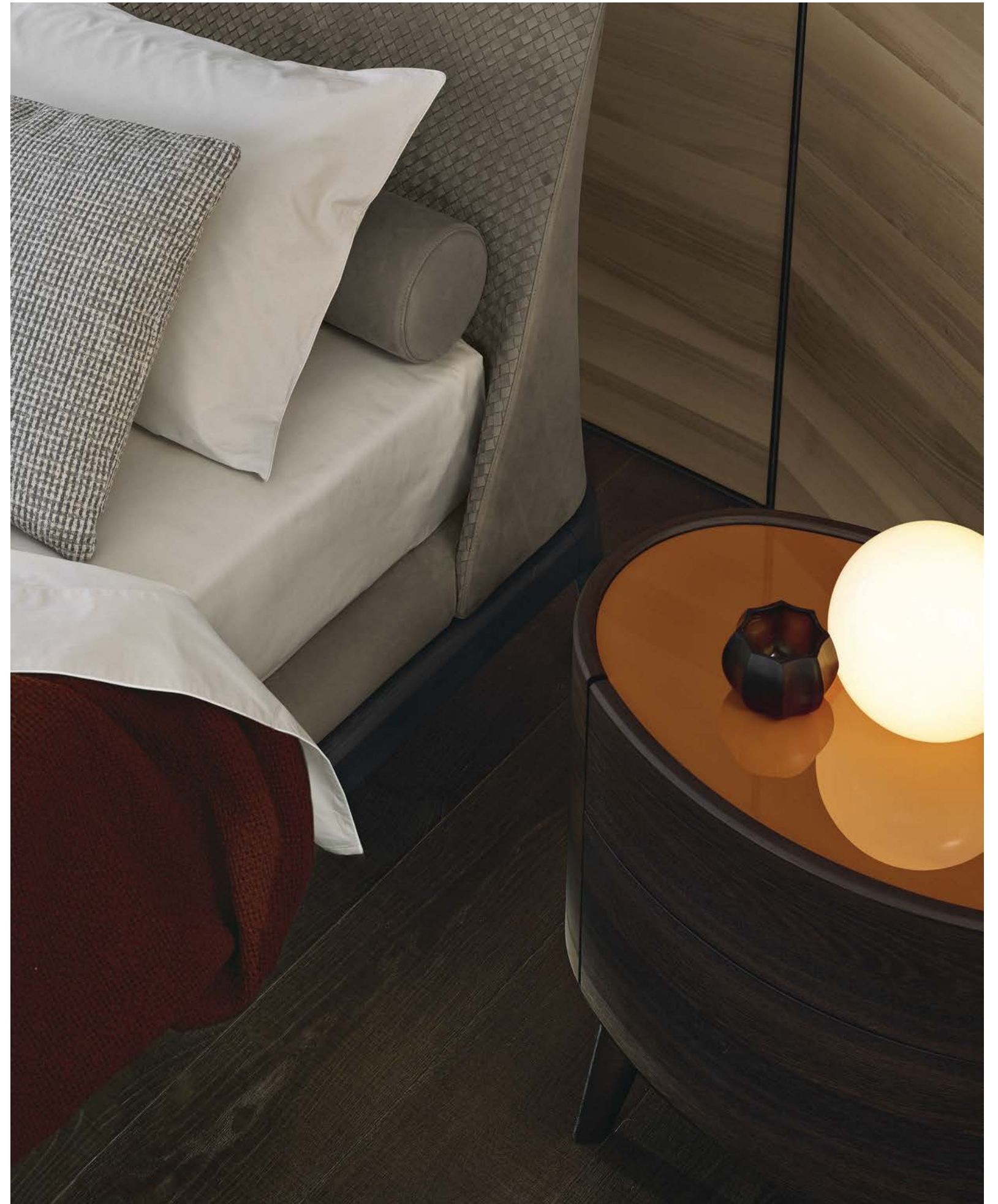



Nella pagina precedente: comodino Kelly in rovere spessart con top laccato lucido caramello e piedini in brown nickel lucido. Letto Kelly, testata imbottita con rivestimento non sfoderabile, esterno in pelle Nabuk 02 tortora, interno in pelle Nabuk intrecciata 02 tortora. Base letto in rovere spessart e parte interna con rivestimento non sfoderabile in pelle Nabuk 02 tortora. In questa pagina: cassetiera Kelly in rovere spessart con top in cuoio 29 tortora e piedini in brown nickel lucido. Pouf Gant con rivestimento in pelle Soft 14 oliva.

On the previous page: Kelly night table in spessart oak with caramello glossy lacquered top and feet in glossy brown nickel. Kelly bed, padded headboard with non-removable covering, outer part in leather Nabuk 02 tortora, inner part in woven leather Nabuk 02 tortora. Bed frame in spessart oak and inner part with non-removable covering in leather Nabuk 02 tortora. On this page: Kelly chest of drawers in spessart oak with top in hide 29 tortora and feet in glossy brown nickel. Gant pouf covered in leather Soft 14 oliva.

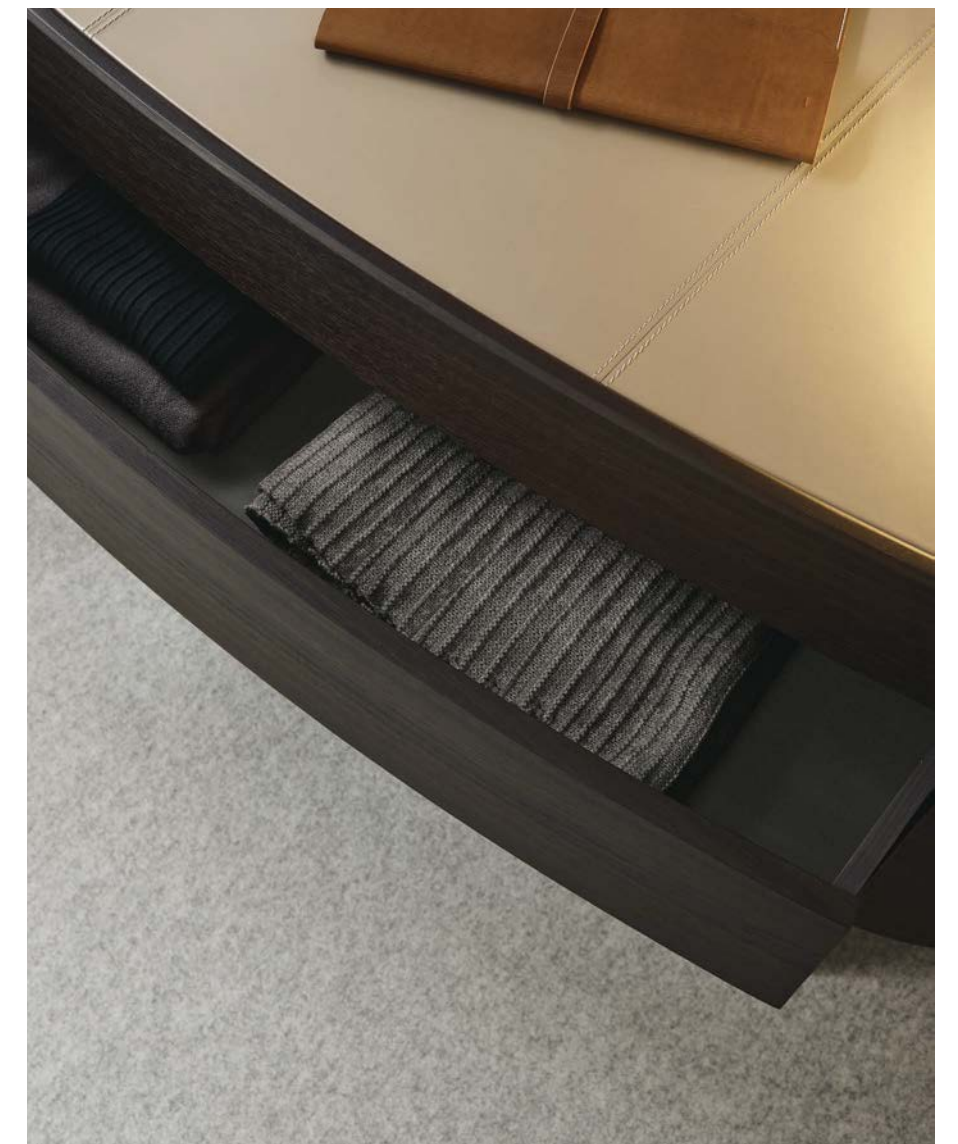

In questa pagina: comodino Kelly in noce gold con top in marmo zecevo levigato. Nella pagina successiva: cassetiera e comodini Kelly nella versione con piedini, in olmo nero con top in marmo calacatta levigato e piedini in brown nickel opaco.

On this page: Kelly night table in gold walnut with top in mat zecevo marble. On the next page: Kelly chest of drawers and night tables in version with feet, in black elm with top in mat calacatta marble and feet in mat brown nickel.





In questa pagina: cassetiera Kelly in noce gold con top in cuoio 02 nero e mensola superiore in vetro fumé.

On this page: Kelly chest of drawers in gold walnut with top in hide 02 nero and top shelf in fumé glass.

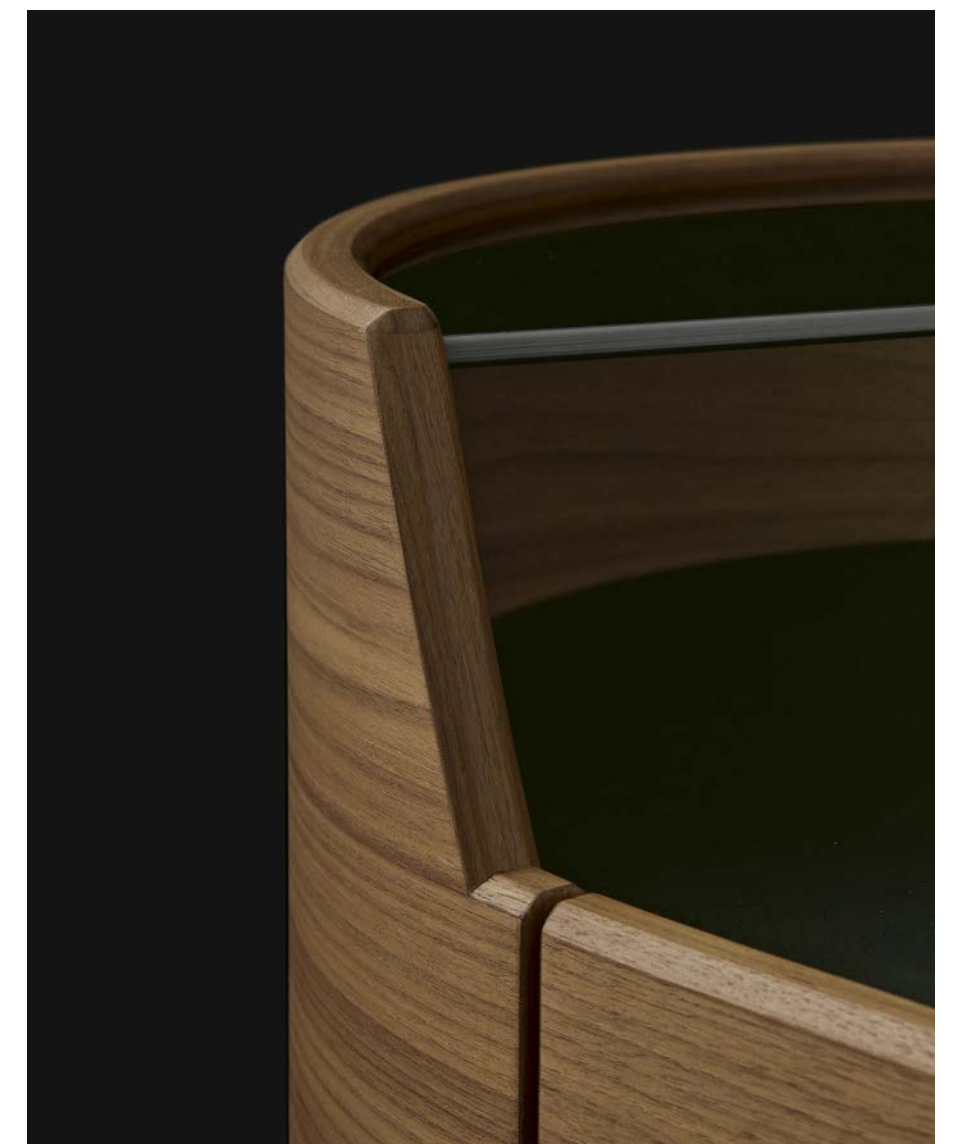



In questa pagina: cassetiera Kelly in olmo nero con top in marmo calacatta oro lucido e piedini in brown nickel lucido. Specchio Audrey con cornice in olmo nero, specchio bronzato e struttura in brown nickel satinato. Pouf Play con rivestimento sfoderabile in tessuto Sendai 02 tortora. Sotto: dettaglio della cassetiera Kelly in olmo nero con top in marmo calacatta oro lucido. Nella pagina successiva: comodino Kelly in olmo nero con top in cuoio 26 invecchiato.

On this page: Kelly chest of drawers in black elm with top in glossy calacatta oro marble and feet in glossy brown nickel. Audrey mirror with frame in black elm, bronzed mirror and structure in satin-finished brown nickel. Play pouf with removable covering in fabric Sendai 02 tortora. Below: detail of Kelly chest of drawers in black elm with top in glossy calacatta oro marble. On the next page: Kelly night table in black elm with top in hide 26 invecchiato.





KELLY

Design Emmanuel Gallina, 2017-2019

Struttura e frontali in rovere spessart, olmo nero o noce gold. Top in laccato opaco colori, laccato lucido colori, cuoio colori o cinque marmi levigati e cinque lucidi (escluso emperador dark). Piedini in metallo finitura champagne opaco, brown nickel opaco o brown nickel lucido. Cassettera a terra, con mensola superiore in vetro nella finitura fumé 3050. Attrezzatura per cassettiere: griglia divisoria per primo cassetto.

Structure and fronts in spessart oak, black elm or gold walnut. Top in mat lacquered colours, glossy lacquered colours, hide colours or five mat and five glossy marbles (except emperador dark). Feet in metal with mat champagne, mat brown nickel or glossy brown nickel finish. Floorstanding chest of drawers with top shelf in glass with fumé 3050 finish. Equipment for chest of drawers: partition element for first drawer.

Comodino Night table

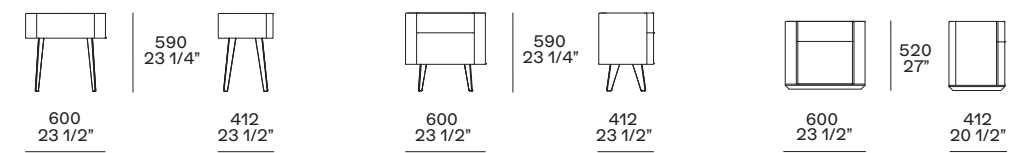

Con piedini.
With feet.

A terra.
Floorstanding.

Cassettera Chest of drawers

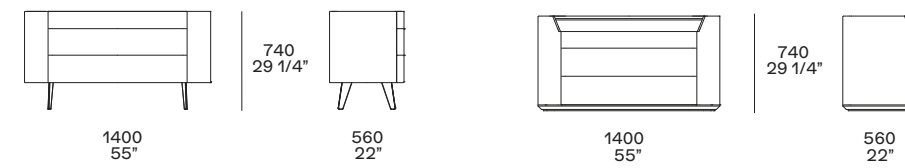

Con piedini.
With feet.

A terra, con mensola superiore in vetro.
Floorstanding, with top shelf in glass.

ONDA

I comodini e la cassetiera Onda reinterpretano la classica forma cilindrica, dall'aspetto sempre attuale. La struttura, in legno massello, si abbina a top realizzati nello stesso materiale o in finiture ricercate.

The Onda night tables and chest of drawers reinterpret the classic cylindrical shape, a timeless look. The structure, in solid wood, matches with tops made of the same material or with refined finishes.



Nella pagina precedente e in chiusura: cassetiera Onda in rovere spessart con top in marmo calacatta oro lucido e maniglie in cuoio 19 caffè. In questa pagina: comodino Onda in rovere spessart con maniglie in cuoio 02 nero. Letto Onda, rivestimento non sfoderabile con lavorazione capitonné in pelle Invecchiata 880 nero, piedini in brown nickel opaco.

On the previous page and at the end: Onda chest of drawers in spessart oak with top in glossy calacatta oro marble and handles in hide 19 caffè. On this page: Onda night table in spessart oak with handles in hide 02 nero. Onda bed, non-removable covering with quilted manufacturing in leather Invecchiata 880 nero, mat brown nickel feet.



In questa pagina: comodini Onda in noce gold con top in marmo zecevo levigato, a sinistra nella versione con due cassetti e maniglie in cuoio 02 nero, a destra nella versione con un cassetto e vano a giorno.

On this page: Onda night tables in gold walnut with top in mat zecevo marble, on the left in the version with two drawers and handles in hide 02 nero, on the right in the version with one drawer and open compartment.

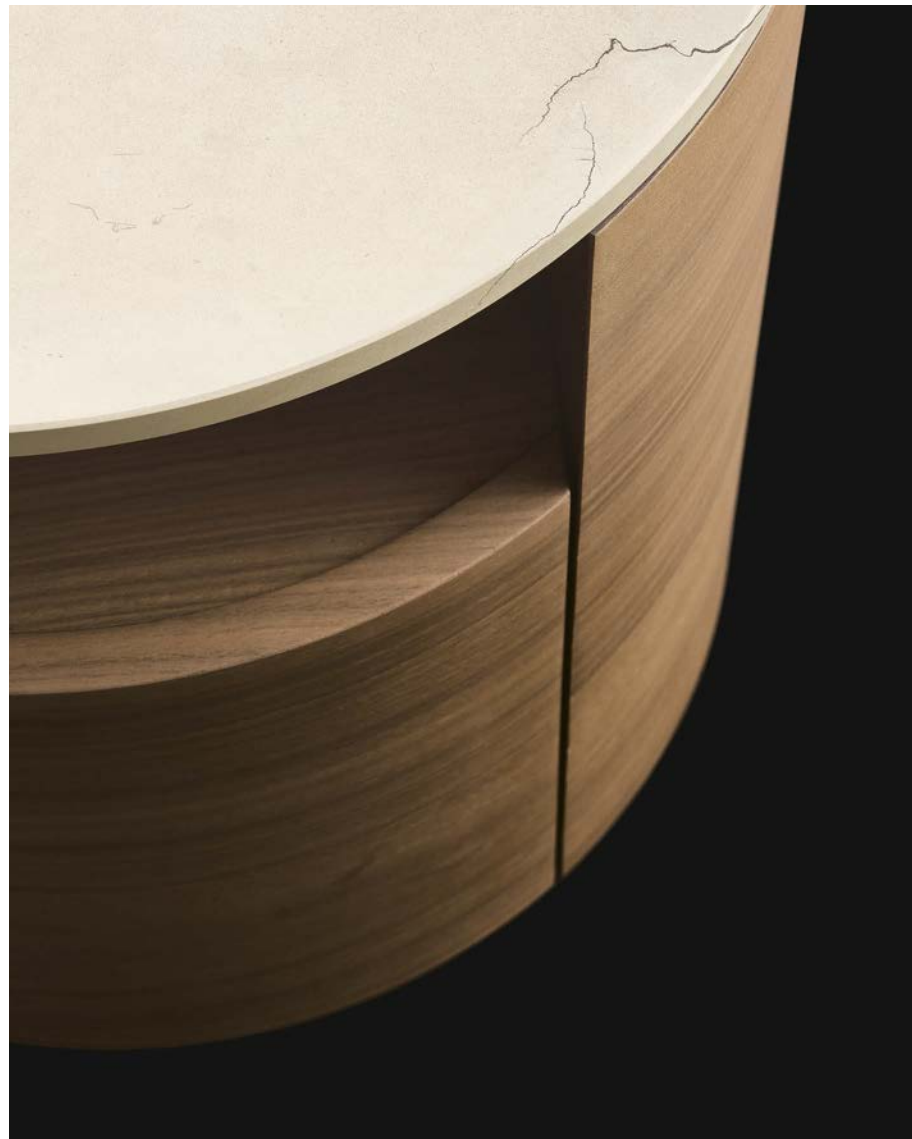



In questa pagina: cassetiera Onda in noce gold con top in marmo zecevo levigato e maniglie in cuoio 02 nero.

On this page: Onda chest of drawers in gold walnut with top in mat zecevo marble and handles in hide 02 nero.

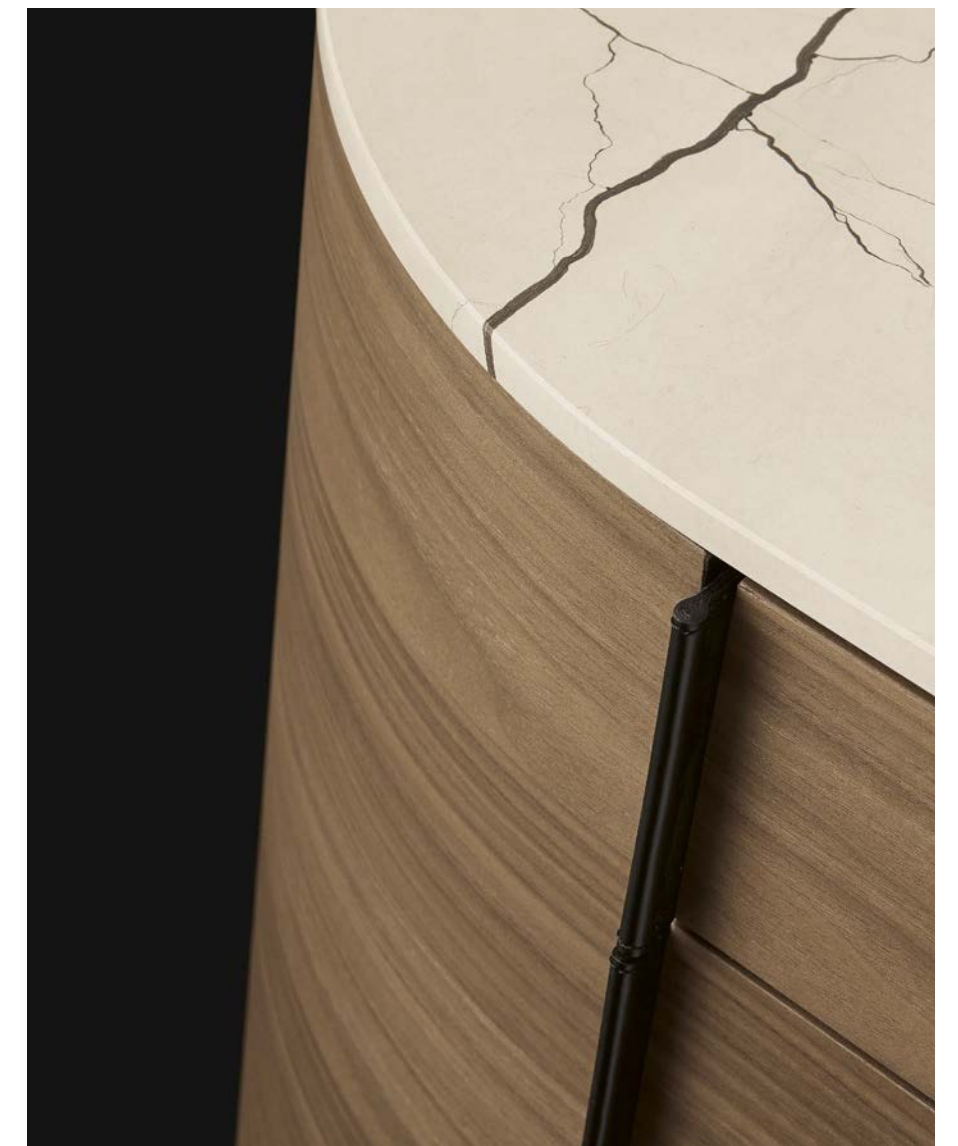

In questa pagina: comodino Onda in rovere spessart, piano in marmo calacatta oro lucido e maniglie in cuoio 19 caffè. Letto Laze, testata e base imbottite con rivestimento sfoderabile in pelle Nabuk 02 tortora. Nella pagina successiva: dettaglio della cassetiera Onda in rovere spessart con top in marmo calacatta oro lucido e maniglie in cuoio 19 caffè. Cassetto superiore attrezzato con griglia divisoria in melamina ardesia e fondo rivestito in cuoio 19 caffè.

On this page: Onda night table in spessart oak, top in glossy calacatta oro marble and handles in hide 19 caffè. Laze bed, padded headboard and bed frame with removable covering in leather Nabuk 02 tortora. On the next page: detail of Onda chest of drawers in spessart oak with top in glossy calacatta oro marble and handles in hide 19 caffè. Top drawer equipped with partition element in ardesia melamine and base covered in hide 19 caffè.

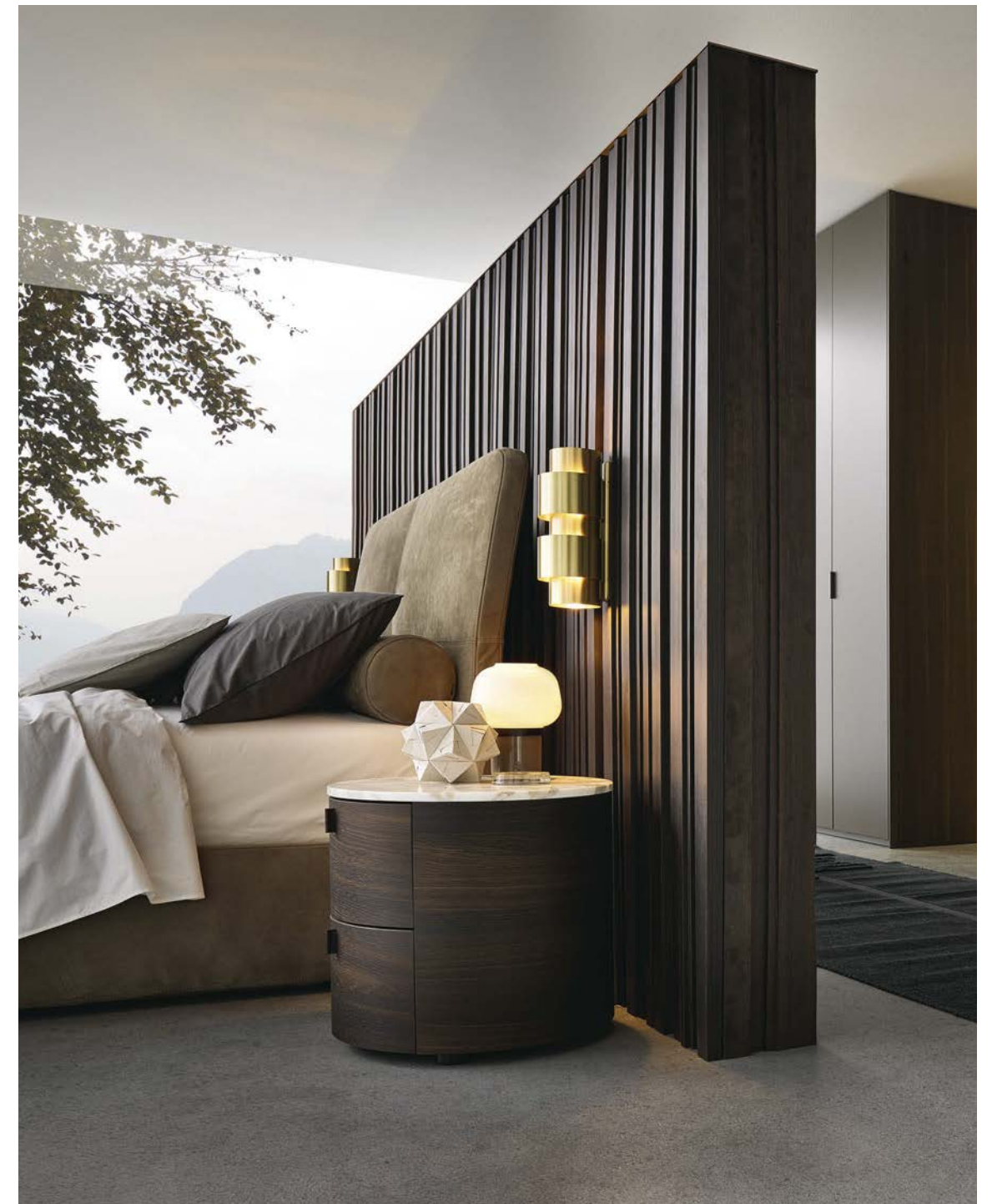



ONDA

Design R&D Poliform, 2014

Struttura e frontali in noce c., noce gold o rovere spessart. Comodini disponibili anche in laccato opaco colori. Top in noce c., noce gold, rovere spessart, cuoio colori o cinque marmi levigati e cinque lucidi (escluso emperador dark).

Maniglia in cuoio colori disponibile per cassettera e per comodino a due cassetti. Attrezzatura per cassettera: griglia divisoria in melamina ardesia per il primo cassetto con fondo rivestito in cuoio colori nel colore della maniglia.

Structure and fronts in walnut c., gold walnut or spessart oak. Night tables also available in mat lacquered colours. Top in walnut c., gold walnut, spessart oak, hide colours or five mat and five glossy marbles (except emperador dark). Handle in the available colours for chest of drawers and for night table with two drawers.

Equipment for chest of drawers: partition element in ardesia melamine for the first drawer with base covered in hide in the same colour as the handle.

Comodino Night table

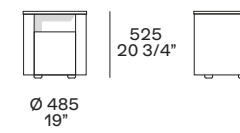

Un cassetto e un vano a giorno.
One drawer and one open compartment.

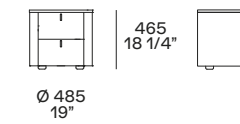

Due cassetti.
Two drawers.

Cassettera Chest of drawers

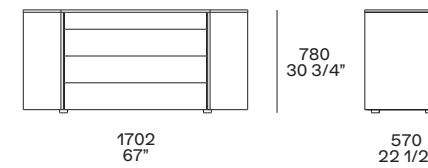

Quattro cassetti.
Four drawers.

ABBINABILI

Per il suo design lineare e senza tempo, la serie Abbinabili si affianca a tutti i letti, negli ambienti più diversi. Particolare la lavorazione a 45° di top e cassetti, che si aprono sul lato. La collezione è completata da un settimanale con quattro cassetti e ribalta, che diventa un elegante secrétaire con accessori in essenza.

Thanks to its linear and timeless design, the Abbinabili series matches all beds in the most diverse environments. It features particular, 45-degree details for the tops and drawers, which open on the side. The collection is completed by a four-drawer chest with flap, which becomes an elegant secrétaire with wooden accessories.



Nella pagina precedente: comodi Abbinabili in rovere spessart. Letto Park 1, testata imbottita con rivestimento sfoderabile, esterno in pelle Soft 14 oliva e interno in tessuto Nayoro 02 sabbia. Base letto in brown nickel opaco e pelle sfoderabile Soft 14 oliva. In questa pagina: cassetiera Abbinabili in rovere spessart. Poltrone Stanford con rivestimento non sfoderabile in tessuto Orleans 12 carbone e basamento girevole in brown nickel lucido. Tavolino Soori in metallo finitura bronzo anticato.

On the previous page: Abbinabili night tables in spessart oak. Park 1 bed, padded headboard with removable covering, outer part in leather Soft 14 oliva and inner part in fabric Nayoro 02 sabbia. Bed frame in mat brown nickel and removable leather Soft 14 oliva. On this page: Abbinabili chest of drawers in spessart oak. Stanford armchair with non-removable covering in fabric Orleans 12 carbone and swivel base in glossy brown nickel. Soori coffee table in metal with antique bronze finish.



In questa pagina: comodini Abbinabili in laccato lucido e opaco canapa, nelle due dimensioni disponibili. Nella pagina successiva: a sinistra cassetiera Abbinabili a otto cassetti in rovere spessart, a destra cassetiera Abbinabili a quattro cassetti in laccato opaco roccia.

On this page: Abbinabili night tables in glossy and mat lacquered canapa, in the two available sizes. On the next page: on the left, Abbinabili chest of drawers with eight drawers in spessart oak, on the right, Abbinabili chest of drawers with four drawers in mat lacquered roccia.







In questa pagina: cassetiera Abbinabili con anta ribalta attrezzata in laccato lucido danubio. Interno ribalta in noce dogato con vassoio estraibile, divisori e cassetto. Nella pagina successiva: comodini Abbinabili in rovere spessart. Letto Park 1, testata imbottita con rivestimento sfoderabile, esterno in pelle Soft 14 oliva e interno in tessuto Nayoro 02 sabbia. Base letto in brown nickel opaco e pelle sfoderabile Soft 14 oliva. Panca Park, seduta con rivestimento non sfoderabile in pelle Soft 14 oliva, struttura in brown nickel opaco e pelle non sfoderabile Soft 14 oliva. Tavolini Soori in metallo finitura bronzo anticato. Poltrone Stanford con rivestimento non sfoderabile in tessuto Orleans 12 carbone, basamento girevole in brown nickel lucido.

On this page: Abbinabili chest of drawers with flap door in glossy lacquered danubio. Equipment behind flap door in staved walnut with pull-out tray, partitions and drawer. On the next page: Abbinabili night tables in spessart oak. Park 1 bed, padded headboard with removable covering, outer part in leather Soft 14 oliva and inner part in fabric Nayoro 02 sabbia. Bed frame in mat brown nickel and removable leather Soft 14 oliva. Park bench, seat with non-removable covering in leather Soft 14 oliva, structure in mat brown nickel and non-removable leather Soft 14 oliva. Soori coffee tables in metal with antique bronze finish. Stanford armchair with non-removable covering in fabric Orleans 12 carbone and swivel base in glossy brown nickel.





ABBINABILI

Design R&D Poliform, 1991

Struttura e frontali in laccato opaco colori, laccato lucido colori o rovere spessart. Cassettiera verticale con anta ribalta attrezzata: interno ribalta nelle finiture noce dogato per la versione laccata o laccato opaco 49 moka per la versione in legno.

Structure and fronts in mat lacquered colours, glossy lacquered colours or spessart oak. Vertical chest of drawers with equipped flap door: interior in staved walnut for lacquered version or mat lacquered moka for wooden version.

Comodino Night table

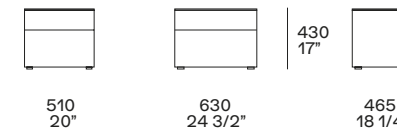

Cassettiera Chest of drawers

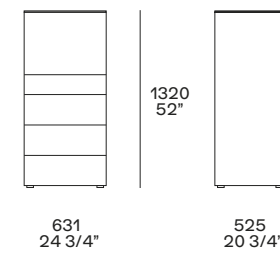
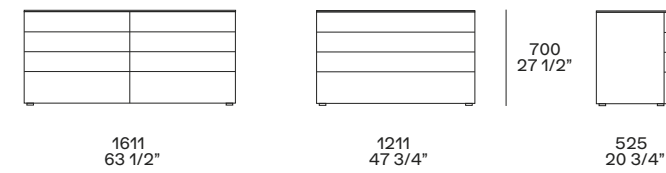

Quattro cassetti e ribalta attrezzata.
Four drawers and equipped flap door.

DREAM

Stile essenziale e contemporaneo per la collezione Dream di Marcel Wanders, vero e proprio sistema che completa tutti i letti della collezione. Un design sempre attuale, declinato in versione comodino, settimanale e cassetiera, anche con scrittoio in appoggio.

Minimalistic and contemporary style for the Dream collection by Marcel Wanders, a true system that completes all the beds in the collection. A timeless design, available in the form of a night table, a seven-drawer chest, and a chest of drawers, also with desk in the version without feet.



Nella pagina precedente: cassetiera Dream in laccato lucido bianco. In questa pagina: comodino Dream in laccato lucido bianco. Letto Dream con pannellatura a muro e base letto con rivestimento sfoderabile in pelle Soft 07 roccia.

On the previous page: Dream chest of drawers in glossy lacquered bianco. On this page: Dream night table in glossy lacquered bianco. Dream bed with wall panelling and bed frame with removable covering in leather Soft 07 roccia.



In questa pagina: comodini Dream in laccato lucido e opaco moka, nelle tre dimensioni disponibili. Nella pagina successiva: cassetiera Dream a sette cassetti in laccato lucido granata, cassetiera Dream a tre cassetti in laccato opaco moka con piano scrittoio in rovere spessart.

On this page: Dream night tables in glossy and mat lacquered moka, in the three available sizes. On the next page: Dream chest of drawers with seven drawers in glossy lacquered granata, Dream chest of drawers with three drawers in mat lacquered moka with writing desk in spessart oak.





In questa pagina: cassetiera Dream in laccato opaco roccia. Nella pagina successiva: cassettiere Dream in laccato opaco visone.

On this page: Dream chest of drawers in mat lacquered roccia. On the next page: Dream chest of drawers in mat lacquered visone.





DREAM

Design Marcel Wanders, 2006

Struttura e frontali in laccato opaco colori o laccato lucido colori. Piano scrittoio in laccato opaco colori, laccato lucido colori o rovere spessart.

Structure and fronts in mat lacquered colours or glossy lacquered colours. Writing desk in mat lacquered colours, glossy lacquered colours or spessart oak.

Comodino Night table

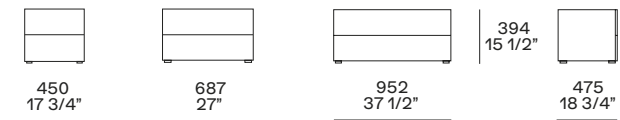

Cassettiera Chest of drawers

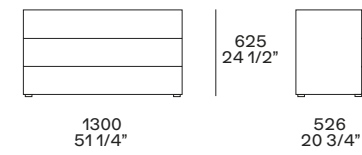

Piano scrittoio Writing desk

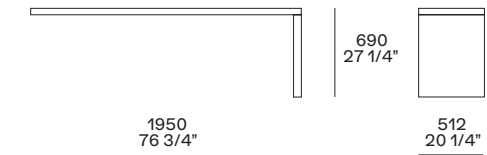

Da sormontare alla cassettiera, totalmente o parzialmente.
To place above the chest of drawers, totally or partially.

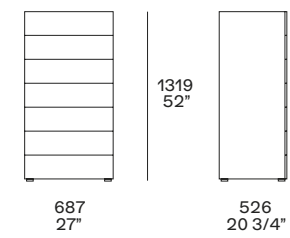



CHLOE

Per accompagnare il letto Chloe, Carlo Colombo progetta una serie di complementi ispirati al disegno della testata, ripiegata verso l'interno. Nei comodini e nella cassetiera Chloe, i fianchi di sostegno in metallo rivestiti in cuoio si trasformano così in un dettaglio iconico che conquista per leggerezza e personalità.

To accompany the Chloe bed, Carlo Colombo designs a series of complements inspired by the design of the headboard, folded inwards. In the Chloe night tables and chest of drawers, the metal support sides covered in hide thus transform into an iconic detail that captivates with its lightness and personality.





Nella pagina precedente: cassetiera Chloe con struttura esterna in cuoio 29 tortora e interna in brown nickel lucido, cassetti e top in olmo nero. Pouf New York con rivestimento sfoderabile in tessuto Zante 10 nero e piedini brown nickel lucido. Tappeto Frame perla. In questa pagina e in chiusura: comodini Chloe con struttura esterna in cuoio 29 tortora e interna in brown nickel lucido, cassetti e top in olmo nero. Letto Chloe, testata e base imbottite con rivestimento sfoderabile in tessuto Naxos 07 cemento, bordure gros-grain color acciaio.

On the previous page: Chloe chest of drawers with outer structure in hide 29 tortora and inner structure in glossy brown nickel, drawers and top in black elm. New York pouf with removable covering in fabric Zante 10 nero and feet in glossy brown nickel. Carpet Frame perla. On this page and at the end: Chloe night tables with outer structure in hide 29 tortora and inner structure in glossy brown nickel, drawers and top in black elm. Chloe bed, padded headboard and bed frame with removable covering in fabric Naxos 07 cemento, grosgrain piping colour acciaio.



In questa pagina: comodini Chloe con struttura esterna in cuoio 26 invecchiato e interna in brown nickel opaco, cassetti in olmo nero e top in marmo sahara noir levigato.

On this page: Chloe night tables with outer structure in hide 26 invecchiato and inner structure in mat brown nickel, drawers in black elm and top in mat sahara noir marble.

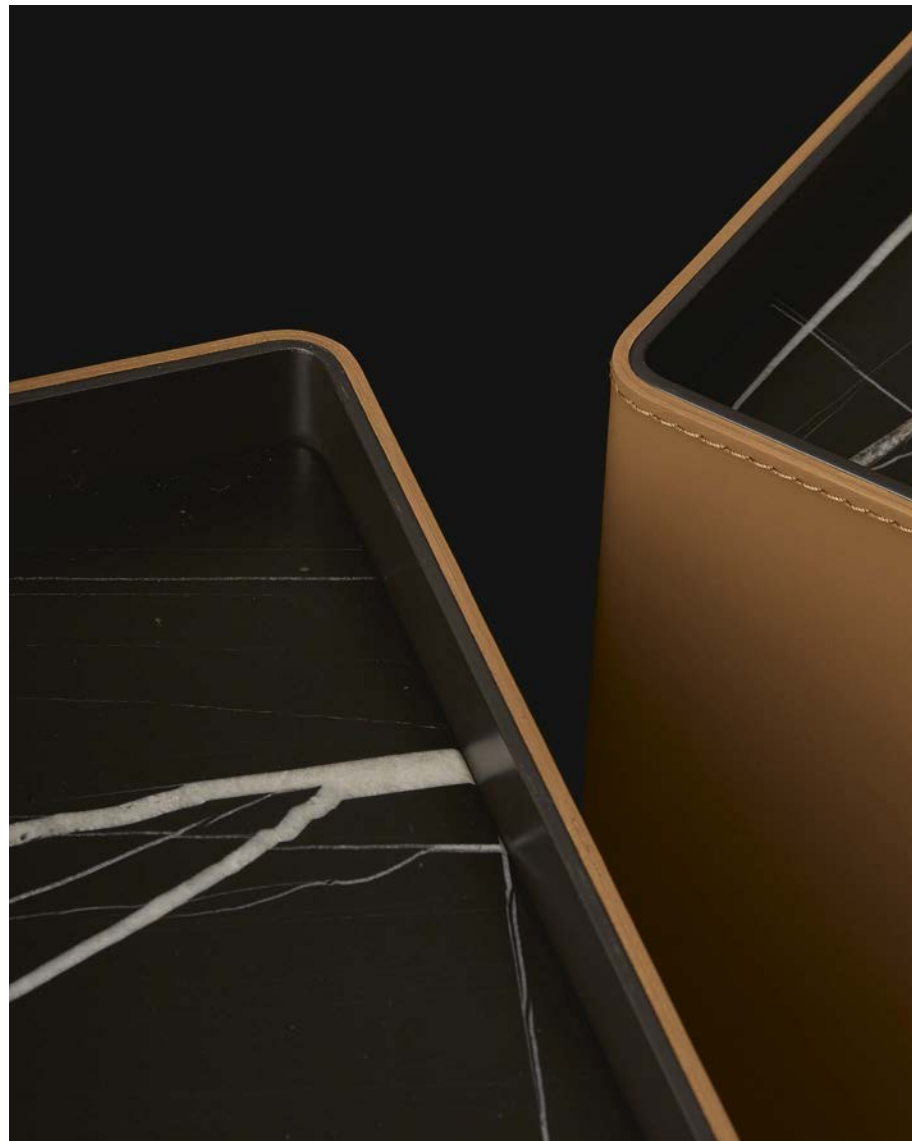



In questa pagina: cassetiera Chloe con struttura esterna in cuoio 02 nero e interna in brown nickel lucido, cassetti in olmo nero e top in marmo zecevo levigato.

On this page: Chloe chest of drawers with outer structure in hide 02 nero and inner structure in glossy brown nickel, drawers in black elm and top in mat zecevo marble.





CHLOE

Design Carlo Colombo, 2017

Struttura in alluminio, esterno rivestito in cuoio colori e interno in brown nickel opaco o lucido. Frontali cassetti in olmo nero. Top in olmo nero, cinque marmi levigati e cinque lucidi (escluso emperador dark).

Structure in aluminium, outer part covered in the available colours and inner part in mat or glossy brown nickel. Drawer fronts in black elm. Top in black elm, five mat and five glossy marbles (except emperador dark).

Comodino Night table

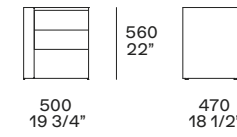

Sinistro. Due cassetti.
Left. Two drawers.

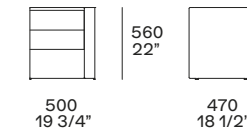

Destro. Due cassetti.
Right. Two drawers.

Cassettiera Chest of drawer

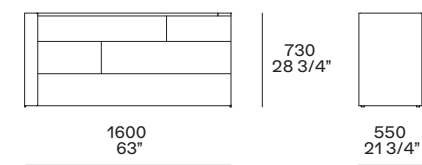

Quattro cassetti.
Four drawers.

YOU

Un'estetica impeccabile e una lavorazione di grande finezza: la collezione You è un'opera di ebanisteria ripensata in chiave contemporanea. La caratteristica stondatura frontale è ripresa anche sul retro, rendendo cassettiere e comodini ideali anche a centrostanza.

An impeccable style and workmanship of great finesse: the You collection is a cabinetry work redesigned with a contemporary interpretation. The characteristic frontal rounding is also on the back, making chests of drawers and night tables ideal even in the middle of the room.





Nella pagina precedente: cassettera You in rovere spessart. Pouf Dune rivestimento sfoderabile in tessuto Rabat 412 cemento. In questa pagina: comodino You in rovere spessart. Letto Arca con testata imbottita trapuntata. Base letto e testata con rivestimento sfoderabile in pelle Nabuk 01 latte.

On the previous page: You chest of drawers in spessart oak. Dune pouf with removable covering in fabric Rabat 412 cemento. On this page: You night table in spessart oak. Arca bed with quilted padded headboard. Bed frame with removable covering in leather Nabuk 01 latte.

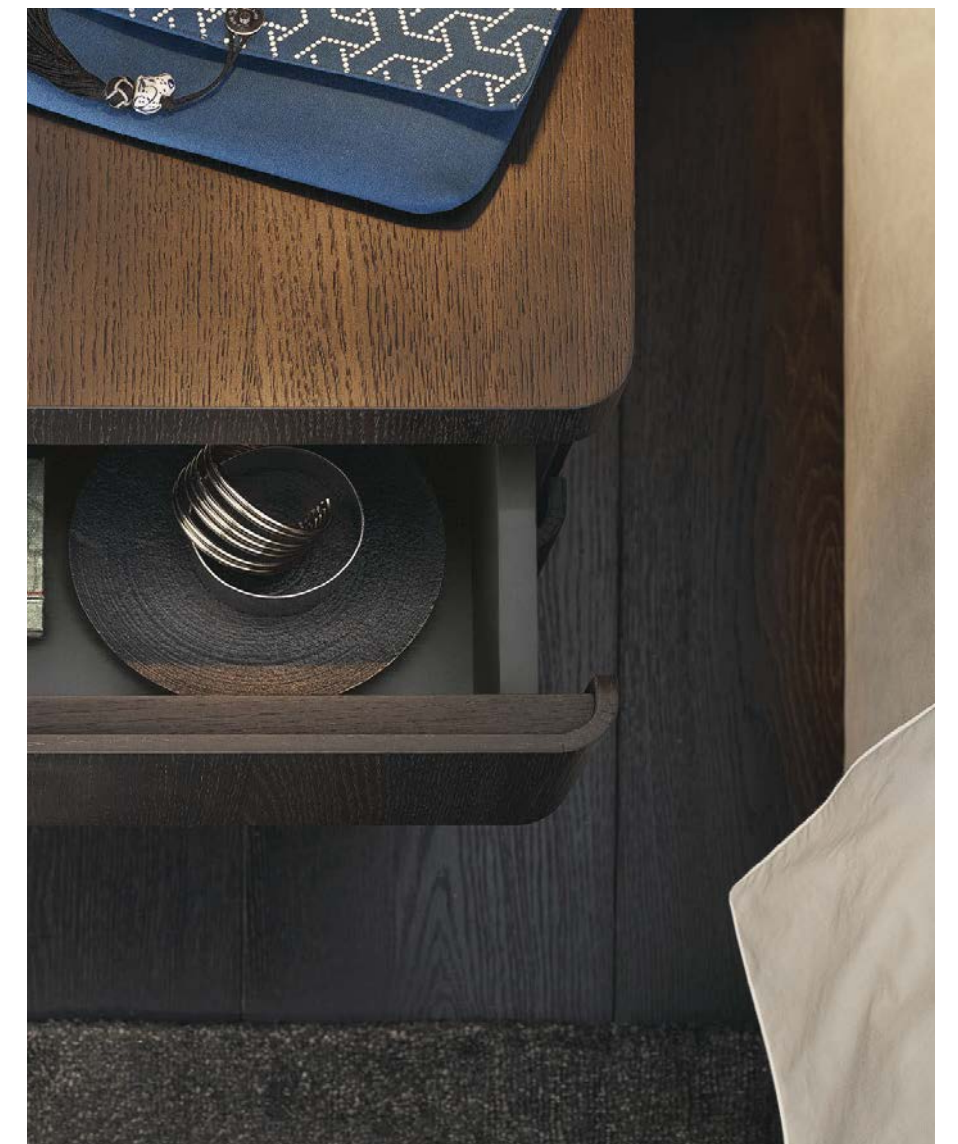

In questa pagina: comodino You in rovere spessart. Nella pagina successiva: cassetiera You in rovere spessart.

On this page: You night table in spessart oak. On the next page: You chest of drawers in spessart oak.

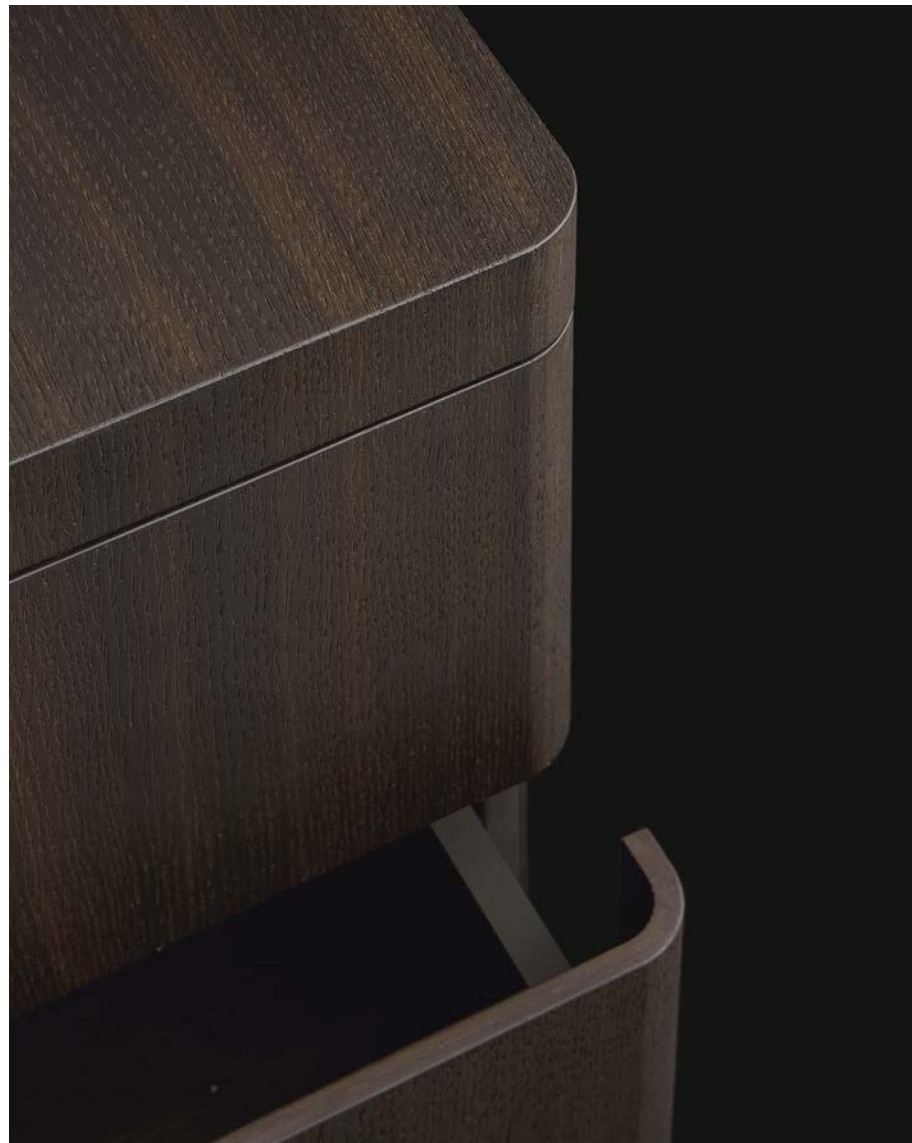





In questa pagina: cassettera You in rovere spessart. Nella pagina successiva: dettaglio del cassetto con le estremità del frontale arrotondate che ne consentono l'apertura.

On this page: You chest of drawers in spessart oak. On the next page: detail of drawer with rounded front ends to allow opening.





YOU

Design D&T, 2010

Struttura in rovere spessart.
Frontali cassetti in rovere spessart.

Structure in spessart oak.
Drawer fronts in spessart oak.

Comodino Night table

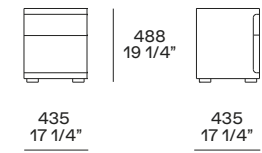

Cassettiera Chest of drawers

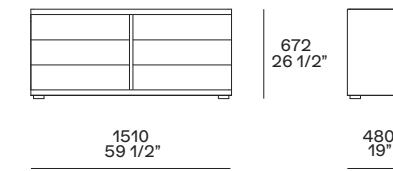
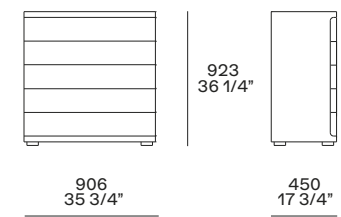

GIÒ

Rodolfo Dordoni propone una collezione trasversale che va dalla zona giorno alla zona notte. Calibrate angolature, particolari ricercati e combinazioni di materiali caratterizzano le cassettiere e il comodino, quest'ultimo con piano in laccato o cuoio e top superiore in vetro.

Rodolfo Dordoni offers a versatile collection that goes from the day area to the night area. Calibrated angles, refined details, and combinations of materials characterize the chests of drawers and the night table, the latter with a lacquered or hide top and a glass upper top.





Nella pagina precedente: cassettera Giò in olmo nero con top laccato lucido canapa e spallette interne fianchi struttura verniciato brown nickel lucido. In questa pagina: comodino Giò in olmo nero con top in cuoio 28 avorio, top superiore in vetro trasparente extrachiaro e spallette interne fianchi struttura verniciato brown nickel lucido.

On the previous page: Giò chest of drawers in black elm with top in glossy lacquered canapa and inner side panels painted in glossy brown nickel. On this page: Giò night table in black elm with top in hide 28 avorio, upper top in extralight transparent glass and inner side panels painted in glossy brown nickel.



In questa pagina: comodino Giò in olmo nero con top in cuoio 29 tortora, top superiore in vetro trasparente extrachiaro e spallette interne fianchi struttura verniciato brown nickel lucido. Nella pagina successiva: cassetiera Giò in olmo nero con top in cuoio 03 grigio scuro e spallette interne fianchi struttura verniciato brown nickel lucido.

On this page: Giò night table in black elm with top in hide 29 tortora, upper top in extralight transparent glass and inner side panels painted in glossy brown nickel. On the next page: Giò chest of drawers in black elm with top in hide 03 grigio scuro and inner side panels painted in glossy brown nickel.

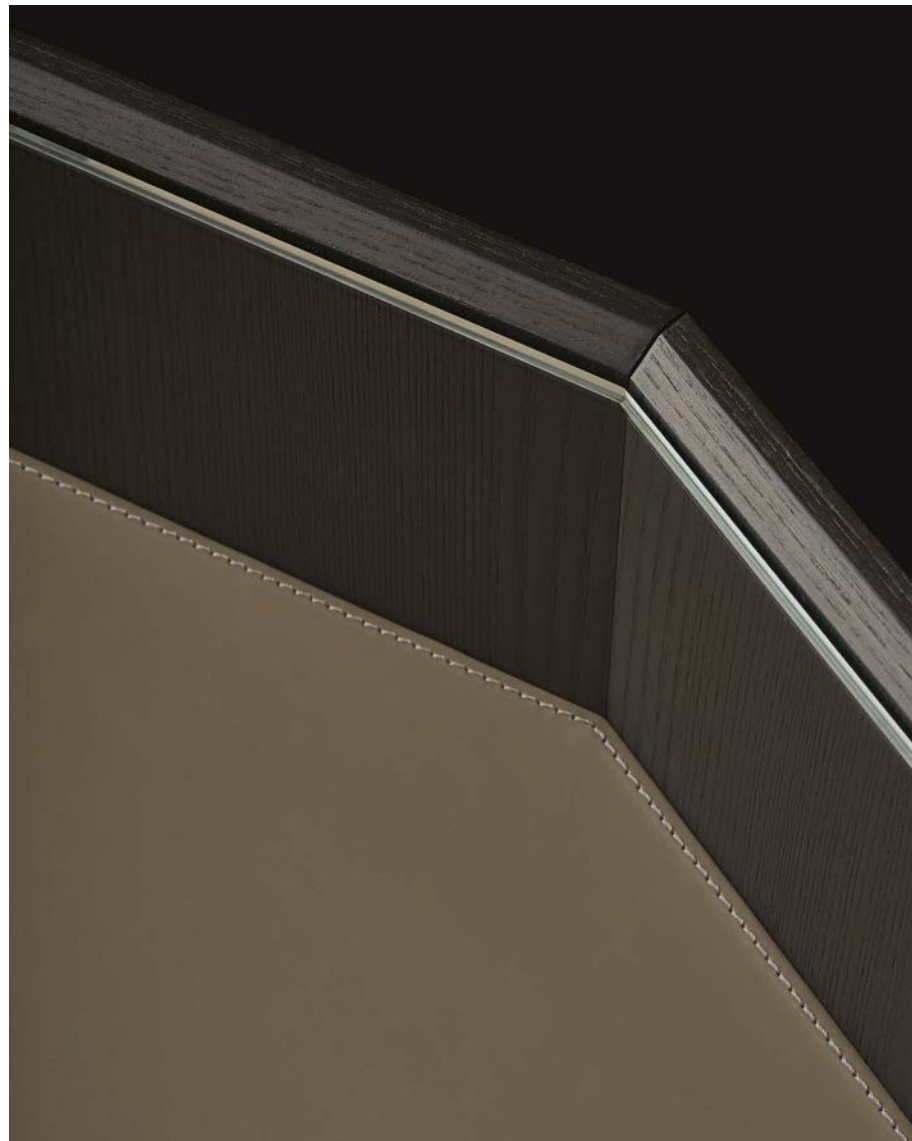





In questa pagina: cassetiera Giò in olmo nero con top laccato lucido caramello e spallette interne fianchi struttura verniciato brown nickel opaco. Nella pagina successiva: cassetiera Giò in olmo nero con top in cuoio 28 avorio. Poltrona Mad Queen rivestimento non sfoderabile, esterno e gambe in pelle Nabuk 01 latte, interno in tessuto Norway 08 avorio. Pouf Onda rivestimento sfoderabile in velluto Persia 2006 prugna.

On this page: Giò chest of drawers in black elm with top in glossy lacquered caramello and inner side panels painted in mat brown nickel. On the next page: Giò chest of drawers in black elm with top in hide 28 avorio. Mad Queen armchair with non-removable covering, outer part and legs in leather Nabuk 01 latte, inner part in fabric Norway 08 avorio. Onda pouf with removable covering in velvet Persia 2006 prugna.





GIÒ

Design Rodolfo Dordoni, 2016

Struttura e frontali cassetti in olmo nero, spallette interne fianchi struttura in brown nickel opaco o lucido. Top laccato lucido colori o rivestito in cuoio colori. Comodino con top in vetro 2000 trasparente extrachiaro. Cassettiera a tre cassetti con gola in brown nickel opaco o lucido. Cassettiere con fondo cassetti rivestito in cuoio colori.

Drawer structure and fronts in black elm, inner side panels in mat or glossy brown nickel. Top in glossy lacquered colours or covered in hide in the available colours. Night table with top in 2000 transparent extralight glass. Chest of drawers with three drawers and groove in mat or glossy brown nickel. Chest of drawers with drawer base covered in hide in the available colours.

Comodino Night table

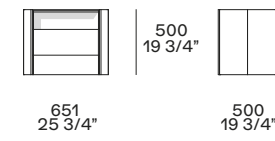

Un cassetto e un vano a giorno.
One drawer and one open compartment.

Cassettiera Chest of drawers

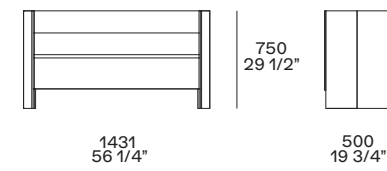

Tre cassetti.
Three drawers.

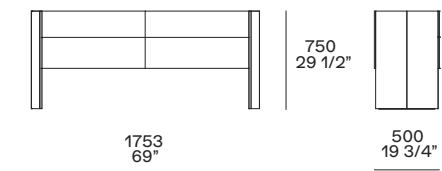

Quattro cassetti.
Four drawers.

MIRRORS

Complementi immancabili nella zona notte, gli specchi riflettono l'ambiente circostante e la luce, oltre che l'immagine di chi li guarda. Funzionalità ed estetica si compenetrano in una collezione dallo stile essenziale dove ad attirare l'attenzione sono dettagli preziosi e finiture ricercate.

Essential complements of the night area, mirrors reflect not only your image, but the surrounding environment and the light. Functionality and style combine in a collection with a minimalist look where precious details and refined finishes captivate your attention.

MIRRORS

AUDREY

263

SARA

273

CIRCLE

283

AUDREY



Audrey è uno specchio romantico e minimale, disegnato da Emmanuel Gallina. La versione a parete ne esalta i contorni morbidi e la cornice sottile, mentre la versione da appoggio a terra mette in luce la particolare lavorazione del retro e il raffinato supporto in metallo. Lo specchio è disponibile nelle due versioni chiara o bronzata.

Audrey is a romantic and minimalistic mirror, designed by Emmanuel Gallina. The wall version enhances the soft edges and the thin frame, while the floor version highlights the particular detail work of the back and the refined metal support. The mirror is available in the light or the bronze version.



Nella pagina introduttiva: specchio Audrey con cornice in olmo nero, specchio bronzato e cavalletto in champagne satinato. Nella pagina precedente: specchio Audrey con cornice in olmo nero, specchio bronzato e cavalletto in brown nickel satinato. Cassettera Kelly in olmo nero con top in marmo calacatta oro lucido e piedini in brown nickel lucido. Pouf Play con rivestimento sfoderabile in tessuto Sendai 02 tortora. In questa pagina: specchio Audrey con cornice in olmo nero e specchio bianco.

On the introductory page: Audrey mirror with frame in black elm, bronzed mirror and stand in satin-finished champagne. On the previous page: Audrey mirror with frame in black elm, bronzed mirror and stand in satin-finished brown nickel. Kelly chest of drawers in black elm with top in glossy calacatta oro marble and feet in glossy brown nickel. Play pouf with removable covering in fabric Sendai 02 tortora. On this page: Audrey mirror with frame in black elm and white mirror.





In questa pagina: specchio Audrey con cornice in olmo nero e specchio bronzato. Nella pagina successiva: specchio Audrey con cornice in olmo nero, specchio bronzato e cavalletto in brown nickel opaco. Pouf Onda rivestimento sfoderabile in velluto Persia 1402 muschio. Tappeto Frame gold.

On this page: Audrey mirror with frame in black elm and bronzed mirror. On the next page: Audrey mirror with frame in black elm, bronzed mirror and stand in mat brown nickel. Onda pouf with removable covering in velvet Persia 1402 muschio. Carpet Frame gold.





AUDREY

Design Emmanuel Gallina, 2018

Specchio da terra con cavalletto o da parete
comprensivo di supporto per fissaggio
a muro. Struttura in legno con cornice
in massello, finitura olmo nero. Colore
specchio 4051 bronzato o 4000 bianco.
Cavalletto in metallo brown nickel satinato
o champagne satinato.

Floorstanding mirror with stand or wall-
mounted inclusive of wall fixing support.
Wood structure with solid wood frame,
black elm finish. Mirror colour 4051 bronzed
or 4000 bianco. Stand in satin-finished
brown nickel or satin-finished champagne
metal.

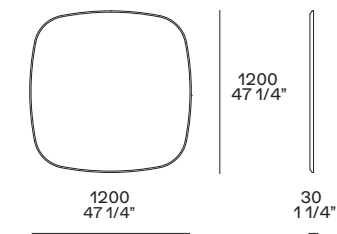
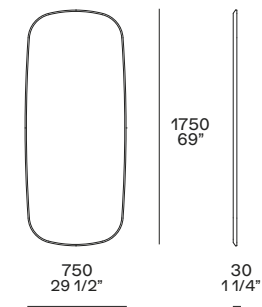
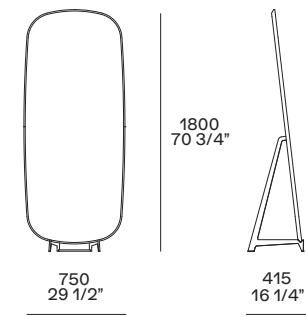

Fissaggio a muro, orizzontale o verticale.
Wall fixing, horizontal or vertical.

SARA

Flaviano Capriotti riduce lo specchio alla più pura essenzialità. Il risultato è la massima pulizia della superficie riflettente, circondata da una cornice sottile che regala stili diversi a seconda della finitura scelta – metallica, laccata o in cuoio.

Flaviano Capriotti reduces the mirror to the purest minimalism. The result is maximum cleanliness of the reflective surface, surrounded by a thin frame that offers different styles depending on the chosen finish – metal, lacquer or hide.



Nella pagina precedente: specchio Sara con cornice in brown nickel opaco e specchio bianco. In questa pagina: specchio Sara con cornice in cromo nero satinato e specchio bianco.

On the previous page: Sara mirror with frame in mat brown nickel and white mirror. On this page: Sara mirror with frame in brushed black chrome and white mirror.



In questa pagina e nella successiva: specchio Sara con cornice in cuoio 29 tortora, cuciture a vista e specchio bianco.

On this page and next page: Sara mirror with frame in hide 29 tortora, visible stitching and white mirror.



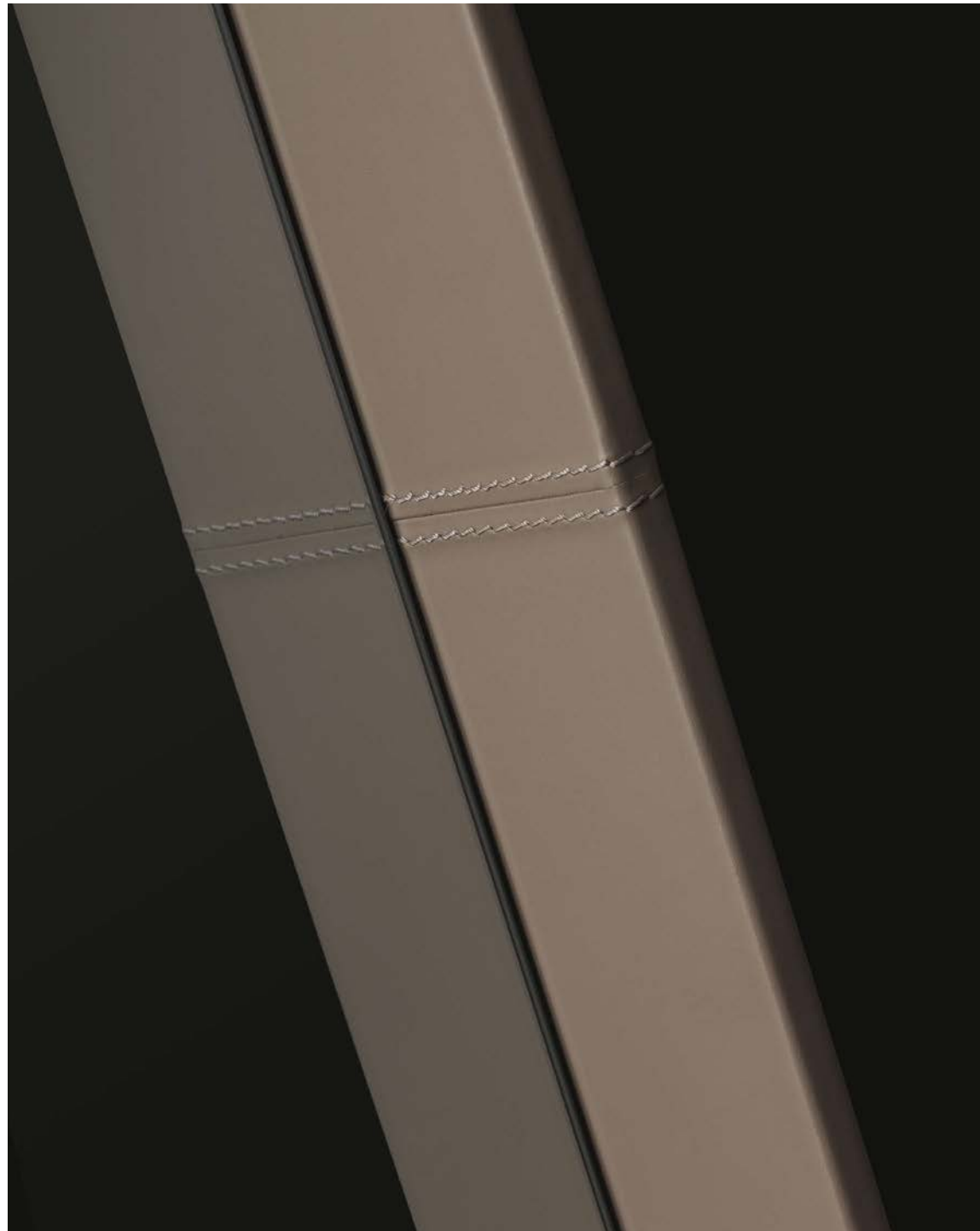

SARA

Design Flaviano Capriotti, 2010

Specchio da parete comprensivo di supporto per fissaggio a muro o di gommini antiscivolo per posizionamento a terra. Profilo in alluminio laccato opaco colori, brown nickel opaco o lucido, champagne opaco, cromo nero, cromo nero satinato o rivestito in cuoio colori. Colore specchio 4000 bianco.

Wall mirror inclusive of wall fixing support or non-slip rubber supports for floor positioning. Aluminium profile in mat lacquered colours, mat or glossy brown nickel, mat champagne, black chrome, brushed black chrome or covered in hide in the available colours. Mirror colour 4000 bianco.

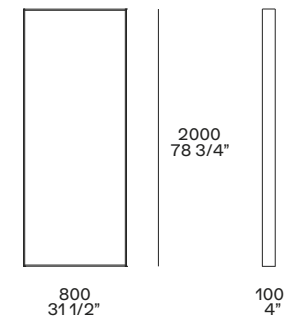

CIRCLE

La perfezione geometrica del cerchio incontra l'eleganza della cornice in cuoio: nasce così Circle, uno specchio da parete che arreda con semplicità ogni ambiente.

The geometric perfection of the circle meets the elegance of the hide frame: thus rises Circle, a wall mirror that furnishes any environment with simplicity.



Nella pagina precedente: specchio Circle con cornice in cuoio 02 nero e specchio bianco. Madia Code in noce gold con top in marmo zecevo levigato, vani a giorno in laccato opaco ottone. Basamento con piedini champagne opaco. Boiserie Code in tessuto lino chiaro e profili champagne opaco. Pouf New York con rivestimento sfoderabile in tessuto Antea 05 terra di siena. In questa pagina: specchio Circle con cornice in cuoio 26 invecchiato e specchio bianco.

On the previous page: Circle mirror with frame in hide 02 nero and white mirror. Code sideboard in gold walnut with top in mat marble zecevo, ottone mat lacquered open compartments. Base with mat champagne feet. Code wall panelling in fabric lino chiaro and mat champagne profiles. New York pouf with removable cover in fabric Antea 05 terra di siena. On this page: Circle mirror with frame in hide 26 invecchiato and white mirror.





In questa pagina: specchio Circle con cornice in cuoio 02 nero e specchio bianco. Nella pagina successiva: specchio Circle con cornice in cuoio 26 invecchiato e specchio bianco. Cabina armadio Senzafine in nobilitato olmo con fianchi a telaio in champagne opaco e schienali in metacrilato roller latte. Cassettiere a vetrina laccato opaco champagne e cassetti inferiori in vetro riflettente fumé con maniglia Track champagne opaco.

On this page: Circle mirror with frame in hide 02 nero and white mirror. On the next page: Circle mirror with frame in hide 26 invecchiato and white mirror. Senzafine walk-in closet in elm melamine with frame sides in mat champagne and backs in roller latte methacrylate. Display case chest of drawers mat lacquered champagne and lower drawers in fumé reflecting glass with mat champagne Track handle.





CIRCLE

Design R&D Poliform, 2019

Specchio da parete comprensivo di supporto per fissaggio a muro. Cornice in metallo rivestita in cuoio nei colori 02 nero e 26 invecchiato. Colore specchio 4000 bianco.

Wall mirror inclusive of wall fixing support. Metal frame covered in hide in the colours 02 nero and 26 invecchiato. Mirror colour 4000 bianco.

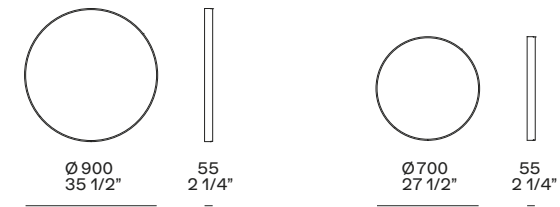

BED ACCESSORIES

RETI BEDSTEADS	294
MATERASSI MATTRESSES	296
RIVESTIMENTI MATERASSI E ACCESSORI MATTRESS COVERS AND ACCESSORIES	298
INSERTI GUANCIALI PILLOWS INSERTS	300
INSERTI PIUMINI DUVETS	301
COLLEZIONE BIANCHERIA LINEN COLLECTION	302

RETI BEDSTEADS

Le reti Poliform sono progettate per garantire il corretto equilibrio fra elasticità di movimento e rigidità di supporto. Tutte le reti sono in faggio con doghe flessibili.

Poliform bedsteads are projected to grant the best balance of firm support and flexibility in the movements. All the bedsteads are in beech wood with flexible slats.

Rete fissa Fixed bedstead



In faggio con doghe flessibili montate ad incastro nel telaio perimetrale. Nella zona corrispondente al bacino le doghe sono raddoppiate per assicurare un maggiore sostegno e sono dotate di cursori per regolare la flessibilità.
Bedstead in beech wood with flexible slats fitted into the perimeter frame. In the pelvis area, the slats are doubled to grant the best support and are provided of sliders to adjust the flexibility.
Dimensioni mm: l 800-900-1000-1400-1600-1800-2000 p 2000-2100 h 55.
Queen size l 1525 x p 2030.
King size l 1930 x p 2030.
Dimensions in: w 31 1/2"-35 1/2"-39 1/4"-55" 63"-70 3/4"-78 3/4" x d 78 3/4"-82 3/4" h 2 1/4". Queen size w 60" x d 80". King size w 76" x d 80".

Rete anatomica con movimento manuale Anatomic bedstead with manual movement



In faggio con doghe flessibili montate a coppia su supporti in gomma. Nella zona lombare le doghe sono raddoppiate per assicurare un maggiore sostegno e sono dotate di cursori per regolare la flessibilità. Movimento manuale della sola testiera. Consigliato l'utilizzo di materassi singoli di tipo standard o in lattice.
Bedstead in beech wood with flexible slats fixed on pair on rubber supports. In the pelvic area, the slats are doubled to grant the best support and are provided of sliders to adjust the flexibility. Manual headboard movement. We suggest the use of single standard mattresses or latex mattresses.
Dimensioni mm: l 800-900-1000 p 2000-2100 h 70.
Dimensions in: w 31 1/2"-35 1/2"-39 1/4" d 78 3/4"-82 3/4" h 2 3/4".

Rete anatomica Anatomic bedstead



In faggio con doghe flessibili montate a coppia su supporti in gomma, con movimento indipendente, distanziate per facilitare l'aerazione del materasso. Nella zona corrispondente al bacino le doghe sono raddoppiate per assicurare un maggiore sostegno e sono dotate di cursori per regolare la flessibilità.
Bedstead in beech wood with flexible slats fixed on pair on rubber supports, with independent movement, spaced to facilitate the ventilation of the mattress. In the pelvis area, the slats are doubled to grant the best support and are provided of sliders to adjust the flexibility.
Dimensioni mm: l 800-900-1000 p 2000-2100 h 70.
Dimensions in: w 31 1/2"-35 1/2"-39 1/4" d 78 3/4"-82 3/4" h 2 3/4".

Contenitore con rete ribaltabile Container box with tip-up bedstead



Rete con telaio in metallo e movimento assistito da ammortizzatori. Doghe flessibili in faggio montate ad incastro nel telaio.
Bedstead with metal frame, movement assisted by shock absorbers. Flexible slats in beech wood joint assembled in the frame.
Dimensioni mm: l 1000-1400-1600-1800-2000 x p 2000-2100.
Queen size l 1525 x p 2030.
King size l 1930 x p 2030.
Dimensions in: w 39 1/4"-55"-63"-70 3/4" 78 3/4" x d 78 3/4"-82 3/4".
Queen size w 60" x d 80".
King size w 76" x d 80".

MATERASSI MATTRESSES

Comfort

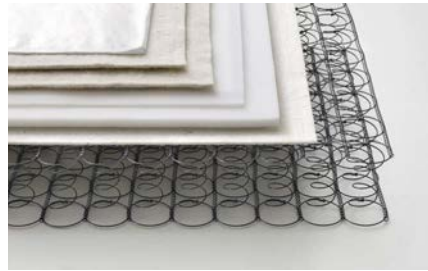

Materasso a molle con imbottitura di irrigidimento in feltro agugliato, termofissato e fonoassorbente da entrambi i lati. Imbottitura termica con lato estivo in cotone e lato invernale in lana. Rivestimento non sfoderabile in 100% raso viscosa ritorto con trattamento antiacaro Sanitized® o in tessuto sfoderabile antimicrobico Amicor Pure™.

Spring mattress with padding is in sound absorbent needle-punched thermo-fixed reinforcement felt on both sides. Thermal padding with summer side in white stabilized cotton and winter side in white needle-punched wool. Non-removable cover in 100% twisted viscose satin with anti-mite treatment Sanitized® or in removable antimicrobial fabric Amicor Pure™.

h 160-180 / 6 1/4"- 7".

Ortopedico



Materasso a molle ad alta densità con imbottitura di irrigidimento in feltro agugliato, termofissato e fonoassorbente da entrambi i lati. Imbottitura termica con lato estivo in cotone e lato invernale in lana. Rivestimento non sfoderabile in 100% raso viscosa ritorto con trattamento antiacaro Sanitized® o in tessuto sfoderabile antimicrobico Amicor Pure™.

High-density spring mattress with padding in sound absorbent needle-punched thermo-fixed reinforcement felt on both sides. Thermal padding with summer side in white stabilized cotton and winter side in white needle-punched wool. Non-removable cover in 100% twisted viscose satin with anti-mite treatment Sanitized® or in removable antimicrobial fabric Amicor Pure™.

h 160-180 / 6 1/4"- 7".

Relax



Materasso a molle insacchettate singolarmente con imbottitura di irrigidimento in feltro agugliato e termofissato, per garantire la massima silenziosità. Imbottitura termica con lato estivo in cotone e lato invernale in lana. Rivestimento non sfoderabile in 100% raso viscosa ritorto con trattamento antiacaro Sanitized® o in tessuto sfoderabile antimicrobico Amicor Pure™.

Mattress with boxed springs in steel wire with padding in sound absorbent needle-punched reinforcement felt. Thermal padding with summer side in white carded and stabilized cotton and winter side in white needle-punched wool. Non-removable cover in 100% twisted viscose satin with anti-mite treatment Sanitized® or in removable antimicrobial fabric Amicor Pure™.

h 160-180 / 6 1/4"- 7".

Benessere



Materasso a molle rivestite singolarmente. Imbottitura di irrigidimento in feltro fonoassorbente e in materiale viscoelastico. Il viscoelastico h 20 recupera la propria forma originaria in modo graduale e costante. Imbottitura termica con lato estivo in cotone e lato invernale in lana. Rivestimento non sfoderabile in 100% raso viscosa ritorto con trattamento antiacaro Sanitized® o in tessuto sfoderabile antimicrobico Amicor Pure™.

Mattress with individually covered springs with padding in sound absorbent felt and viscoelastic material. The viscoelastic material h 20 recovers its original shape in a gradual and constant way. Thermal padding with summer side in cotton and winter side in wool. Non-removable cover in 100% twisted viscose satin with anti-mite treatment Sanitized® or in removable antimicrobial fabric Amicor Pure™.

h 180-200 / 7"- 7 3/4".

Benessere Plus



Materasso a molle rivestite singolarmente con rivestimento antiacaro. Imbottitura di irrigidimento in feltro fonoassorbente e in materiale viscoelastico. Il viscoelastico h 25 recupera la propria forma originaria in modo graduale e costante. Imbottitura 100% in fibra anallergica. Rivestimento in tessuto antimicrobico Amicor Pure™ sfoderabile.

Mattress with individually covered springs with anti-mite cover. Stiffening padding in sound absorbent felt and viscoelastic material. The viscoelastic material h 25 recovers its original shape in a gradual and constant way. Padding 100% in hypoallergenic fiber. Cover in removable antimicrobial fabric Amicor Pure™.

h 240/250 / 9 1/2"- 9 3/4".

Anatomico



Materasso a molle insacchettate con 7 zone di portanza differenziata. Imbottitura di irrigidimento in feltro agugliato e termofissato. Imbottitura termica con lato estivo in cotone e lato invernale in lana. Rivestimento non sfoderabile in 100% raso viscosa ritorto con trattamento antiacaro Sanitized® o in tessuto sfoderabile antimicrobico Amicor Pure™.

Mattress with boxed springs in steel wire with 7 different carrying capacity sections. Stiffening padding in needle-punched and thermofixed felt. Thermal padding with summer side in cotton and winter side in wool. Non-removable cover in 100% twisted viscose satin with anti-mite treatment Sanitized® or in removable antimicrobial fabric Amicor Pure™.

h 160-180 / 6 1/4"- 7".

Luxor



Materasso a molle indipendenti inserite in singoli sacchetti in tessuto immarcescibile che evita la formazione di muffe e altri agenti patogeni. Imbottitura a due strati di cotone pregiato. Rivestimento in 100% raso viscosa ritorto non sfoderabile completo di trattamento antiacaro Sanitized®.

Mattress with independent boxed springs in incorruptible fabric, which prevents the formation of moulds and other pathogens. Two-layer padding in fine cotton. Non-removable cover in 100% twisted viscose satin with anti-mite treatment Sanitized®.

h 240/250 / 9 1/2"- 9 3/4".

Elite



Materasso a molle rivestite singolarmente con rivestimento antiacaro. Il viscoelastico h 25 recupera la propria forma originaria in modo graduale e costante. Imbottitura realizzata al 100% in cotone. Rivestimento interno 100% cotone jersey. Rivestimento in 100% raso viscosa ritorto non sfoderabile completo di trattamento antiacaro Sanitized®.

Mattress with individually covered springs with anti-mite cover. The viscoelastic material h 25 recovers its original shape in a gradual and constant way. Padding in 100% cotton. Inner cover in 100% jersey cotton. Non-removable cover in 100% twisted viscose satin with anti-mite treatment Sanitized®.

h 240/250 / 9 1/2"- 9 3/4".

Elite Plus



Materasso a molle rivestite singolarmente con rivestimento antiacaro. Il viscoelastico h 25 recupera la propria forma originaria in modo graduale e costante. Imbottitura realizzata al 100% in cotone. Rivestimento interno 100% cotone jersey. Rivestimento in 100% raso viscosa ritorto non sfoderabile completo di trattamento antiacaro Sanitized®.

Mattress with individually covered springs with anti-mite cover. The viscoelastic material h 25 recovers its original shape in a gradual and constant way. Padding in 100% cotton. Inner cover in 100% jersey cotton. Non-removable cover in 100% twisted viscose satin with anti-mite treatment Sanitized®.

h 240/250 / 9 1/2"- 9 3/4".

RIVESTIMENTI MATERASSI E ACCESSORI MATTRESS COVERS AND ACCESSORIES

La collezione Poliform prevede due tipologie di rivestimento per i materassi e due accessori dedicati a reti e materassi per garantire un riposo sempre più confortevole e personalizzato.

Poliform collection offers two cover typologies for the mattresses and two accessories for bedsteads and mattresses, ensuring a more comfortable and personalized rest.

Rivestimento Sanitized® Sanitized® cover



Per materassi / for mattresses Anatomico, Benessere, Comfort, Ortopedico, Relax

Rivestimento non sfoderabile in 100% raso viscosa ritorto di colore bianco. Compreso di trattamento antiacaro Sanitized®, una fibra che possiede proprietà fungo-batteriostatiche e antiacaro. I principi attivi sono innocui per la pelle e integrati nelle fibre, senza alcun trattamento superficiale. Lavorazione a trapunta con disegno a rombi stilizzati. Fascia perimetrale trapuntata con 4 maniglie in puro cotone. Non-removable cover in 100% twisted viscose satin in white colour. It includes anti-mite treatment Sanitized®, this fibre has bacteriostatic-antifungal properties and it is effective against mites. The integrated active substances are harmless for the skin and there is no surface chemical treatment. Quilted manufacturing with a stylized diamond pattern. Quilted perimeter band with 4 handles in pure cotton.

Rivestimento Amicor Pure™ Amicor Pure™ cover



Per materassi / for mattresses Anatomico, Benessere, Benessere Plus, Comfort, Ortopedico, Relax

Rivestimento sfoderabile in tessuto antimicrobico Amicor Pure™, una fibra che grazie ad un meccanismo di diffusione costante eroga un additivo sicuro per la pelle e l'ambiente, che elimina gli allergeni e i microbi che abitualmente si annidano nei materassi. Il rivestimento può essere lavato senza comprometterne l'effetto antimicrobico. Removable cover in antimicrobial fabric Amicor Pure™, a fibre that, thanks to a slow spreading mechanism supplies a barely adequate quantity of a safe additive for both the skin and the environment. This substance eliminates allergens and microbes, which are usually in mattresses. The antimicrobial effect is not eliminated by washing the cover.

Coprirete Bedstead cover



Disponibile solo per rete fissa. Rivestimento in cotone colore ardesia, confezione a cappuccio con elastico, supporto in TNT nero. Lavorazione a trapunta con disegno a rombi stilizzati. Completo di 4 elastici negli angoli. Lavabile esclusivamente a secco. It is available only for fixed bedstead. Cover in cotton colour ardesia, hood covering with elastic band, support in black non-woven fabric. Quilted manufacturing with a stylized diamond pattern. Complete with 4 elastic bands in the corners. Dry clean only. Dimensioni mm: l 800-900-1000-1400 1600-1800-2000 x p 2000-2100. Queen size l 1525 x p 2030. King size l 1930 x p 2030. Dimensions in: w 31 1/2"-35 1/2"-39 1/4"-55" 63"-70 3/4"-78 3/4" x d 78 3/4"-82 3/4". Queen size w 60" x d 80". King size w 76" x d 80".

Topper Topper



Rivestimento non sfoderabile 100% raso viscosa ritorto, imbottitura in lana e seta. Completo di 4 elastici negli angoli. Non-removable cover in 100% twisted viscose satin, padding in wool and silk. Complete with 4 elastic bands in the corners. Dimensioni mm: l 1600-1800-2000 x p 2000-2100. Queen size l 1525 x p 2030. King size l 1930 x p 2030. Dimensions in: w 63"-70 3/4"-78 3/4" x d 78 3/4"-82 3/4". Queen size w 60" x d 80". King size w 76" x d 80".

INSERTI GUANCIALI PILLOWS INSERTS

**Dacron
Dacron**



Imbottitura in ovatta di poliestere traspirante. Igienico, anallergico e di facile manutenzione. Offre una piacevole sensazione di soffici ta e comfort, adattandosi alla testa e al collo, tornando poi alla propria forma. Fodera 100% cotone sfoderabile e lavabile.
Padding in aerating polyester wadding. Hygienic, anti-allergenic and easy to maintain. This pillow offers a pleasant sensation of softness and comfort, adapting to head and neck and returning to the original shape in a slow way. Cover in 100% removable and washable cotton.
Guanciaie dimensioni mm: 500 x 800 500 x 900.
Pillow dimensions in: 19 3/4" x 31 1/2" 19 3/4" x 35 1/2".

**Piuma d'oca
Goose feathers**



Imbottitura in 100% piuma d'oca sterilizzata. Le alte capacit  traspiranti garantiscono una temperatura di riposo uniforme. Assorbe l'umidit  e favorisce l'evaporazione del calore in eccesso. Fodera 100% cotone sfoderabile e lavabile.
Padding in goose feathers 100%. Thanks to the high ventilation temperature will remain static throughout the night. It absorbs humidity and lets exceeding heat evaporate. Cover in 100% removable and washable cotton.
Guanciaie dimensioni mm: 500 x 800 500 x 900.
Pillow dimensions in: 19 3/4" x 31 1/2" 19 3/4" x 35 1/2".

**Piumino d'oca
Goose down**



Imbottitura in 80% piumino d'oca e 20% piuma d'oca sterilizzata. Le alte capacit  traspiranti garantiscono una temperatura di riposo uniforme. Assorbe l'umidit  e favorisce l'evaporazione del calore in eccesso. Fodera 100% cotone sfoderabile e lavabile.
Padding in 80% goose down and 20% sterilized goose feather. Thanks to the high ventilation temperature will remain static throughout the night. It absorbs humidity and lets exceeding heat evaporate. Cover in 100% removable and washable cotton.
Guanciaie dimensioni mm: 500 x 800 500 x 900.
Pillow dimensions in: 19 3/4" x 31 1/2" 19 3/4" x 35 1/2".

**Rullo
Roll-cushion**



Imbottitura in dacron, fodera 100% cotone, rivestimento sfoderabile in tessuto o pelle.
Padding in dacron, cover 100% cotton, removable cover in fabric or leather.
Dimensioni mm: l 780 - 800 - 880 - 900 Ø 150-200.
Per letti Kelly e Park1   consigliato Ø 150.
Per letti Arca, Chloe, Dream, Jacqueline, Laze, Onda e Rever   consigliato Ø 200.
Dimensions in: w 30 3/4" - 31 1/2" - 34 3/4" 35 1/2" Ø 6"-7 3/4".
For beds Kelly and Park1 suggested Ø 6".
For beds Arca, Chloe, Dream, Jacqueline, Laze, Onda and Rever suggested Ø 7 3/4".

INSERTI PIUMINI DUVETS

**Piuma
Feather**



Imbottitura 50% piumino, 50% piumetta d'oca/anatra da gr. 325/mq, fodera 100% cotone.
Stuffed with 50% down and 50% plumule of goose/duck of 325 grams per sqm, lining 100% cotton.
Dimensioni mm: l 2000-2500-2800 p 2000.
Dimensions in: w 78 3/4" - 98 1/2" - 110 1/4" d 78 3/4".

**Dacron
Dacron**



Imbottitura in Dacron DuPont, fodera 100% cotone.
Stuffed with Dacron DuPont, cover 100% cotton.
Dimensioni mm: l 2000-2500-2800 p 2000.
Dimensions in: w 78 3/4" - 98 1/2" - 110 1/4" d 78 3/4".

**Fiberfill doppia stagione
Fiberfill "double season"**



Imbottitura fiberfill, formato da 2 inserti accoppiati e utilizzabili separatamente.
Stuffed with fiberfill, composed of two coupled inserts which can be used separately.
Dimensioni mm: l 2000-2500-2800 p 2000.
Dimensions in: w 78 3/4" - 98 1/2" - 110 1/4" d 78 3/4".

**COLLEZIONE BIANCHERIA
LINEN COLLECTION**

Il progetto Poliform dedicato alla zona notte comprende una collezione di biancheria letto coordinata, in cotone Provence con una gamma di sette colori e profilo a "coda di topo" a contrasto o tono su tono.

The Poliform project for the bed accessories includes a bed linen collection in cotton Provence available in seven colours with piping in contrast or matching colours.



Set estivo

2 federe guanciaie, lenzuolo sotto, lenzuolo sopra. Disponibile per larghezze materasso l 1000-1400-1600-1800-2000.

Set invernale

2 federe guanciaie, lenzuolo sotto, copripiumino. Disponibile per larghezze materasso l 1000-1400-1600-1800-2000.

Federe

Disponibili per coppia guanciali. Dimensioni 500 x 800 - 500 x 900.

Lenzuolo sotto/sopra

Disponibile per larghezze materasso l 1000 1400-1600-1800-2000.

Sacco copripiumino

Disponibile per larghezze materasso l 1000 1400-1600-1800-2000.

Summer bed-set

2 pillow cases, fitted sheet, top sheet. Available for mattresses width w 39 1/4"-55" 63"-70 3/4"-78 3/4".

Winter bed-set

2 pillow cases, fitted sheet, duvet cover. Available for mattress width w 39 1/4" 55"-63"-70 3/4"-78 3/4".

Pillow cases

Available for pillow couple. Dimensions 19 3/4" x 31 1/2" - 19 3/4" x 35 1/2"

Upper/lower sheet

Available for mattress width w 39 1/4"-55" 63"-70 3/4"-78 3/4".

Eiderdown cover

Available for mattress width w 39 1/4"-55" 63"-70 3/4"-78 3/4".

**Cotone Provence
Cotton Provence**

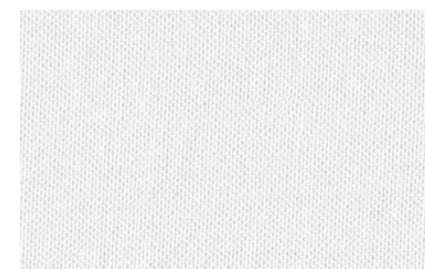

01 bianco

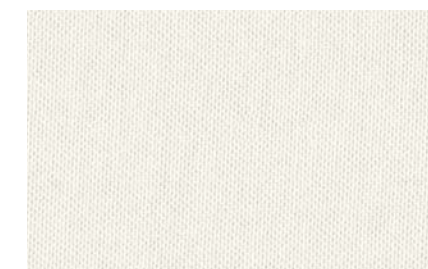

02 panna

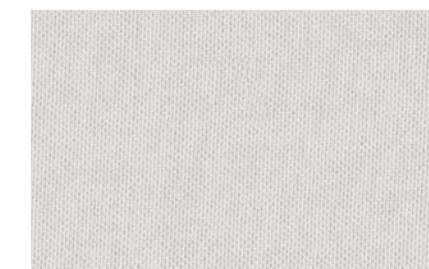

08 polvere



03 ghiaccio



04 tortora



06 roccia



07 grafite

TECHNICAL DATA

TAPPETI
CARPETS

306

FINITURE
FINISHINGS

310

INDICE PRODOTTI
PRODUCT INDEX

318

TAPPETI
CARPETS

Frame

Prodotto a mano con tecnica Handloom.
Trama in cotone, vello in seta di bambù.
Bordo perimetrale di 80 mm in lana
himalayana in tinta solo per la versione
rettangolare.
Dimensioni mm: rettangolare 1700x2400
2300x3000 - 3000x4000
quadrato 3000x3000 - ovale 2300x4000.

Handmade with the Handloom technique.
Cotton weave, fleece in bamboo silk.
80 mm - 3 1/4" perimeter edge in Himalayan
wool in matching colour only for the
rectangular version.
Dimensions in: rectangular 67"x94 1/2"
90 1/2"x118" - 118"x157 1/2"
square 118"x118" - oval 90 1/2"x157 1/2".



Grey



Gold



Perla



Oceano



Prugna



Carbone



Plain

Prodotto a mano con tecnica Handloom.
Trama in cotone, vello in aloe e seta di bambù.
Versione rettangolare bordo di 150 mm in
tonalità più scura sul lato superiore e inferiore
e di 100 mm per la dimensione 1700x2400.
Nella versione tonda la parte più scura è di
1/4 del tappeto.
Dimensioni mm: rettangolare 1700x2400
2300x3000 - 3000x4000
quadrato 3000x3000 - rotondo Ø 2500.

Handmade with the Handloom technique.
Cotton weave, fleece in aloe and bamboo silk.
Rectangular version 150 mm - 6" edge in
darker colour in the upper and lower side and
100 mm - 4" edge for the size 1700x2400.
In the round version the darkest part is 1/4
of the carpet.
Dimensions in: rectangular 67"x94 1/2"
90 1/2"x118" - 118"x157 1/2"
square 118"x118" - round Ø 94 1/2".



Tortora

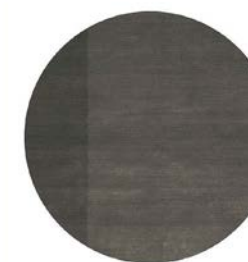

Cipria

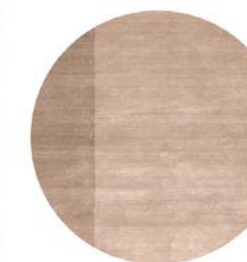

Ruggine



Arena



Natural



TAPPETI
CARPETS

Tratto

Prodotto a mano con tecnica Handloom.
Trama in cotone, vello in lana himalayana e seta di bambù.
Dimensioni mm: rettangolare 1700x2400
2300x3000 - 3000x4000
quadrato 3000x3000.

Handmade with the Handloom technique.
Cotton weave, fleece in Himalayan wool and bamboo silk.
Dimensions in: rectangular 67"x94 1/2" 90
1/2"x118" - 118"x157 1/2" square 118"x118".

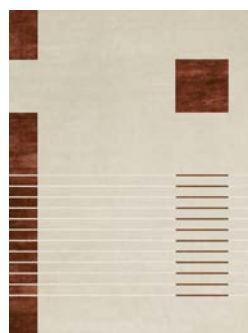

Ruggine

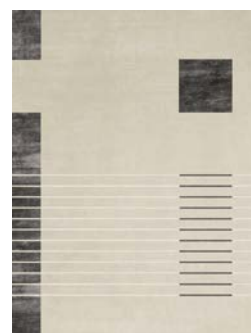

Carbone



Tortora

Soft

Prodotto a mano con tecnica Handloom.
Trama in cotone, vello in seta di bambù grigio sfumato.
Dimensioni mm: rettangolare 1700x2400
2300x3000 - 3000x4000
quadrato 3000x3000.

Handmade with the Handloom technique.
Cotton weave, fleece in bamboo silk shaded grey.
Dimensions in: rectangular 67"x94 1/2"
90 1/2"x118" - 118"x157 1/2"
square 118"x118".



Dama

Prodotto a mano con tecnica Handloom.
Trama in cotone, vello in lana himalayana e seta di bambù.
Dimensioni mm: rettangolare 1100x3500
1700x2400 - 2300x3000 - 3000x4000
quadrato 3000x3000.

Handmade with the Handloom technique.
Cotton weave, fleece in Hymalayan wool and bamboo silk.
Dimensions in: rectangular 43 1/4"x137 1/4"
67"x94 1/2" - 90 1/2"x118" - 118"x157 1/2"
square 118"x118".



Stripes

Prodotto a mano con tecnica Handloom.
Trama in cotone, vello in lana himalayana e seta di bambù.
Dimensioni mm: rettangolare 1100x3500
1700x2400 - 2300x3000 - 3000x4000
quadrato 3000x3000.

Handmade with the Handloom technique.
Cotton weave, fleece in Hymalayan wool and bamboo silk.
Dimensions in: rectangular 43 1/4"x137 1/4"
67"x94 1/2" - 90 1/2"x118" - 118"x157 1/2"
square 118"x118".



FINITURE
FINISHINGS

Laccato opaco
Mat lacquer



82 glacier white 01 bianco 35 canapa 26 corda 88 castoro 46 tortora



64 arena 89 roccia 48 visone 49 moka 04 grafite 91 carbone



60 ghiaccio 09 pioggia 78 ferro 83 oca 85 caramello 67 muschio



92 vischio 87 granata 86 danubio 70 prussia



77 champagne 24 ottone 23 bronzo 90 piombo 02 ardesia

Laccato semilucido
Semi-glossy lacquer



82 glacier white 01 bianco 35 canapa 26 corda 46 tortora 89 roccia



48 visone 04 grafite 91 carbone 87 granata

Laccato lucido
Glossy lacquer



82 glacier white 01 bianco 35 canapa 26 corda 88 castoro 46 tortora



60 ghiaccio 64 arena 48 visone 49 moka 04 grafite 91 carbone



78 ferro 83 oca 85 caramello 92 vischio 87 granata 86 danubio

Laccato antigraffio
Antiscratch lacquer



01 bianco 35 canapa 04 grafite 91 carbone

Laccato metallico
Metallic lacquer



23 bronzo 24 ottone 25 titanio

FINITURE
FINISHINGS

**Essenza
Wood**

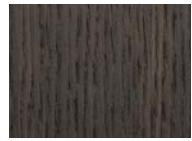

rovere spessart
spessart oak



noce gold
gold walnut



noce c.
walnut c.



olmo nero
black elm



cedro
cedar



rovere naturale
natural oak

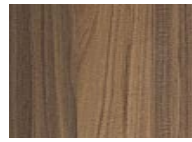

massello noce canaletto
solid walnut canaletto

**Marmo levigato
Mat marble**



bianco carrara



calacatta oro



grigio stardust



emperador dark



sahara noir
finitura poliestere
polyester finish



zecevo

**Marmo lucido
Glossy marble**



bianco carrara



calacatta oro



grigio stardust



emperador dark



sahara noir
finitura poliestere
polyester finish



noir saint laurent

**Gabbro
Gabbro**



nero assoluto
texture juta

**Semiprezioso
Semiprecious**



lapislazzulo blu
blue lapis lazuli

**Onice
Onyx**



ambra
amber

**Cuoio
Hide**



28 avorio



29 tortora



19 caffè



38 oliva



15 prugna



26 invecchiato



03 grigio scuro



02 nero

**Tecnopelle
Techno leather**



05 latte



01 elefante

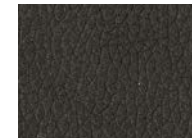

02 moro

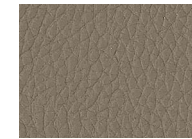

06 nocciola

**Tessuto
Fabric**

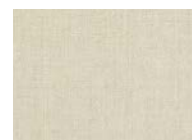

lino chiaro



lino scuro

FINITURE
FINISHINGS

Tessuti
Fabrics

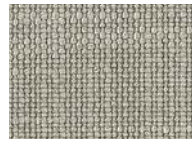

atlanta cat. b
12 colori - colours



caleo cat. b
15 colori - colours



chios cat. b
13 colori - colours



eraclea cat. b
12 colori - colours



aspen cat. c
12 colori - colours

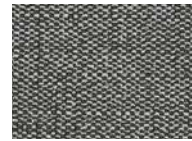

lima cat. c
11 colori - colours



siviglia cat. c
14 colori - colours



antea cat. d
13 colori - colours



caledonia cat. d
9 colori - colours



cordoba cat. d
13 colori - colours



corinto cat. d
5 colori - colours



indra cat. d
12 colori - colours



itaca cat. d
10 colori - colours

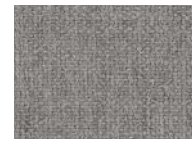

kushiro cat. d
13 colori - colours



lipsi cat. d
11 colori - colours



micene cat. d
9 colori - colours



milos cat. d
5 colori - colours

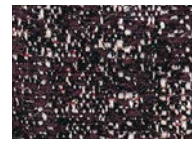

olimpia cat. d
14 colori - colours

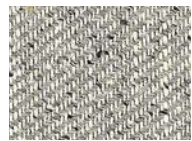

oxford cat. d
8 colori - colours



rabat cat. d
10 colori - colours



sendai cat. d
5 colori - colours



sparta cat. d
12 colori - colours



arcadia cat. e
12 colori - colours



argo cat. e
13 colori - colours

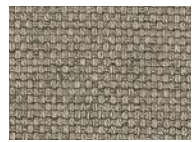

hannover cat. e
11 colori - colours



kitami cat. e
12 colori - colours



merida cat. e
8 colori - colours



naxos cat. e
11 colori - colours



nayoro cat. e
10 colori - colours



norway cat. e
13 colori - colours



orleans cat. e
10 colori - colours



paros cat. e
11 colori - colours



persia cat. e
16 colori - colours



salford cat. e
11 colori - colours



skyros cat. e
12 colori - colours

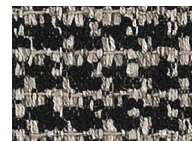

zante cat. e
11 colori - colours



lero cat. g
2 colori - colours



siro cat. g
4 colori - colours

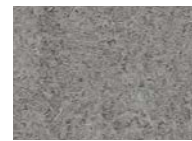

tebe cat. g
11 colori - colours



gibson cat. z
8 colori - colours

Pelle
Leather



spring cat. p
13 colori - colours



colors cat. s
25 colori - colours

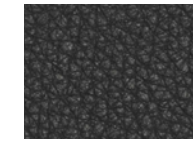

silk cat. s
13 colori - colours



silk intrecciata cat. s
woven leather silk
13 colori - colours



vintage cat. s
5 colori - colours



special cat. x
21 colori - colours



nabuk cat. y
10 colori - colours



nabuk intrecciata cat. y
woven leather nabuk
10 colori - colours



invecchiata cat. y
6 colori - colours



soft cat. y
14 colori - colours

Pelle Cashmere
Cashmere leather



bianco



grigio



nero

Pelle Hairy
Hairy leather



bianco/nero



cappuccino

Bordura gros-grain - bordura in seta - filati
Grosgrain border - silk border - yarns



burro



perla



sahara



rubino

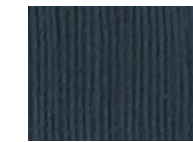

tempesta



navy

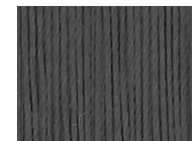

acciaio



nero

● escluso bordura in seta
except silk border

Provence coordinati letto
Bed linen Provence



01 bianco

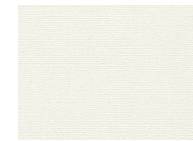

02 panna



08 polvere



04 tortora



06 roccia



07 grafite



03 ghiaccio

FINITURE
FINISHINGS

**Vetro
Glass**

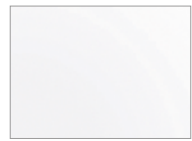

1000 trasparente
transparent



2000 trasparente
extrachiaro-transparent
extralight



3050 fumé



2700 line

**Vetro riflettente
Reflecting glass**

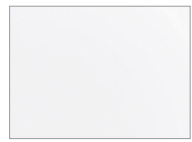

5000 trasparente
transparent



5010 blu



5051 bronzato
bronzed



5059 fumé

**Vetro acidato
Etched glass**



5380 acciaio



5323 bronzo



5325 titanio

**Specchio
Mirror**



4000 bianco
white



4051 bronzato
bronzed

**Vetro satinato
Mat glass**



2301 bianco

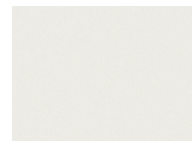

2373 ghiaccio

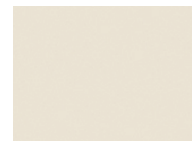

1335 canapa



1364 arena



1304 grafite



1303 nero

**Vetro lucido
Glossy glass**

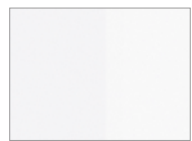

2201 bianco



2273 ghiaccio



1235 canapa



1264 arena

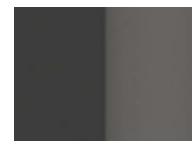

1204 grafite

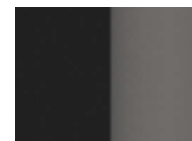

1203 nero



1259 bordeaux

**Nobilitato
Melamine**



olmo
elm

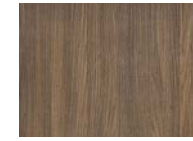

noce c.
walnut c.



rovere cenere
cenere oak



rovere spessart
spessart oak



canvas beige



canvas grigio



graffiti 01 bianco



graffiti 35 canapa



graffiti 60 ghiaccio



silk canapa

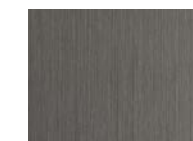

silk grey

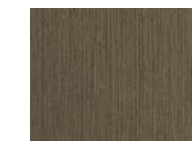

silk bronzo



club 01 bianco



skin
27 colori laccato opaco
27 mat lacquered colours



skin 94 latte
laccato opaco
mat lacquered



skin 97 elefante
laccato opaco
mat lacquered



skin 93 moro
laccato opaco
mat lacquered

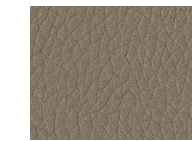

skin 98 nocciola
laccato opaco
mat lacquered

**Nobilitato interno cassetti
Melamine drawers structure**



ardesia



madras
Quid sistema giorno -
day system



roller latte



roller ardesia

**Metacrilato
Methacrylate**

**Parti metalliche
Metal parts**



brown nickel opaco
mat brown nickel

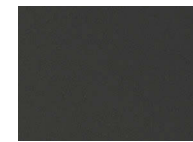

brown nickel lucido
glossy brown nickel



brown nickel satinato
brushed brown nickel



champagne opaco
mat champagne



champagne satinato
brushed champagne



bronzato
bronzed



piombo opaco
mat piombo

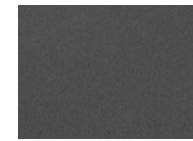

ardesia opaco
mat ardesia



cromo satinato
brushed chrome



cromo nero
black chrome



cromo nero satinato
brushed black chrome



bronzo anticato
antique bronze



spatolato ferro
spatula-finish ferro



spatolato bronzo
spatula-finish bronzo



oro lucido
glossy gold



alluminio brill
aluminium brill

LETTI
BEDS



Kelly, design Emmanuel Gallina
pp. 10-29



Park 1, design Carlo Colombo
pp. 30-45



Jacqueline, design Jean-Marie Massaud
pp. 46-65



Rever, design Rodolfo Dordoni
pp. 66-79



Chloe, design Carlo Colombo
pp. 80-93



Dream, design Marcel Wanders
pp. 94-113



Onda, design Paolo Piva
pp. 114-125



Laze, design Rodolfo Dordoni
pp. 126-139



Arca, design R&D Poliform
pp. 140-155

CONTENITORI
STORAGE UNITS



Kelly, design Emmanuel Gallina
pp. 160-175



Onda, design R&D Poliform
pp. 176-189



Abbinabili, design R&D Poliform
pp. 190-203



Dream, design Marcel Wanders
pp. 204-217



Chloe, design Carlo Colombo
pp. 218-229



You, design D&T
pp. 230-243



Giò, design Rodolfo Dordoni
pp. 244-257

SPECCHI
MIRRORS



Audrey, design Emmanuel Gallina
pp. 262-271



Sara, design Flaviano Capriotti
pp. 272-281



Circle, design R&D Poliform
pp. 282-291

Poliform Spa
via Montesanto 28
Casella postale n. 1
22044 Inverigo (CO) Italy
t +39 031 6951
f +39 031 699444
info@poliform.it
poliform.it



2018 Adi Compasso D'oro
Career Award

Poliform realizza tutte le sue collezioni in Italia usando componenti e materie prime selezionate.

All the Poliform collections are manufactured 100% in Italy using top-class components and materials.

Poliform si riserva il diritto di apportare, senza preavviso, ogni modifica mirata al miglioramento funzionale e qualitativo dei propri prodotti. Testi e disegni presenti in questo stampato hanno scopo divulgativo: per ogni aspetto tecnico e dimensionale fare riferimento ai listini aziendali e relativi aggiornamenti. I campioni di colori e materiali hanno valore indicativo.

Poliform reserves the rights at all time to apply modifications for the functional or qualitative improvement of its products. Texts and drawings present in this brochure have a divulgative purpose: for every technical and dimensional aspect please refer to the company's price lists and their relative updates. The colour and material samples have an indicative value.

Creative Direction
Apartamento Studios

Graphic Design
Apartamento Studios

Interiors Photography
Federico Cedrone, Omar Sartor

Still Life Photography
Silvia Orlandi

Interiors Styling
Poliform Lab

1st edition February 2020
cod. 111/R1/2020



TWENTY TWENTY